

# VEICHI

# Manual

## AC80C Series Frequency Inverter

## VEICHI

Shenzhen Veichi Electric Co., Ltd.

Address: Block C, Wentao Science and Technology Park, Shiyan Yingrenshi  
Community, Baoan District, Shenzhen, China

Phone: +86-0755-29685610, 29685611, 29685612

Fax: +86-0755-29685615

Suzhou Veichi Electric Co., Ltd.

Address: No.111 Wusongjiang Avenue, Guoxiang Street, Wuzhong District,  
Suzhou, China

Website: [www.veichi.com](http://www.veichi.com)



Version:2016 V1.1  
Shenzhen Veichi Electric Co., Ltd.all rights  
reserved, subject to change without notice.

# Contents

<b>Chapter 1 Overview</b> .....	1
1.1 Safety requirement and cautions.....	1
1.2 Technical criterion .....	4
<b>Chapter 2 Before Use</b> .....	7
2.1 Purchase inspection.....	7
2.2 Nameplate .....	7
2.3 Standard models and rated parameters.....	8
<b>Chapter 3 Installation and Wiring</b> .....	9
3.1 Safety Precautions.....	9
3.2 Treatment for inverter after longtime store .....	10
3.3 Inverter stable running environment.....	10
3.4 EMI Protection.....	11
3.5 Machinery installation.....	14
3.6 Electric installation.....	22
<b>Chapter 4 Basic Operation and Trial Run</b> .....	37
4.1 Safety Precautions.....	37
4.2 Keyboard layout and functions specification.....	38
4.3 Basic operation.....	41
4.4 Trial run.....	44
<b>Chapter 5 Fault Diagnoses and Processing</b> .....	54
5.1 Fault types.....	54
5.2 Fault information and details .....	54
5.3 Fault diagnoses process .....	58
<b>Chapter 6 Periodic Overhaul and Maintenance</b> .....	64
6.1 Safety Precautions.....	64
6.2 Overhaul.....	64
6.3 Maintenance.....	66
<b>Chapter 7 Peripheral Equipments and Options</b> .....	69
7.1 Safety Precautions.....	69
7.2 Peripheral equipments.....	69
7.3 The use of peripheral equipments .....	71
<b>Chapter 8 Quality Guarantee</b> .....	74
8.1 Guarantee time and range.....	74
8.2 Liability exemption .....	74
8.3 Product application .....	74
<b>Chapter 9 Function Parameter Specification</b> .....	75
9.1 Basic parameters.....	75
9.2 Operation control parameter.....	84
9.3 Switch quantity terminal parameters.....	90
9.4 Analog terminal parameters .....	103
9.5 Keyboard and display parameters.....	108

9.6 Motor parameters.....	111
9.7 VC control parameter.....	114
9.8 V/F control parameters .....	116
9.9 Malfunction and protection parameters .....	120
9.10 Machine malfunction code table .....	128
9.11 PID parameters.....	130
9.12 Multi-step, PLC function and swing frequency parameters .....	135
9.13 Communication control function parameters .....	139
<b>Chapter 10 Appendix.....</b>	<b>141</b>
10.1 Appendix 1: Function parameter table.....	141
10.2 Appendix 2: RS485 communication protocol.....	173
10.3 Appendix 3: PG card manual.....	181
10.4 Appendix 4: Profibus-DP card manual.....	189
10.5 Appendix 5: LCD keyboard.....	191

## Chapter 1 Overview





Thanks for using AC80C high-performance VC frequency inverter produced by Veichi electric co.,ltd. This manual tells you how to use it perfectly. Please read this manual carefully and fully understand the safety requirement and cautions before use (installation, wiring, operation, maintain, checking, and etc...).

### 1.1 Safety requirement and cautions

Pls do totally understand this part before using the inverter.

#### Warning signs and meanings

This manual has used belowing signs that mean there is an important part of security. While observing against the rules, there is danger of injury even death or machine system damage.

	<b>Danger:</b> Wrong operation may cause death or large accident.
	<b>Warning:</b> Wrong operation may cause death or large accident.
	<b>Caution:</b> Wrong operation may cause minor wound.
	<b>Important:</b> Wrong operation may cause the inverter and other machine system damage

#### Warning signs position

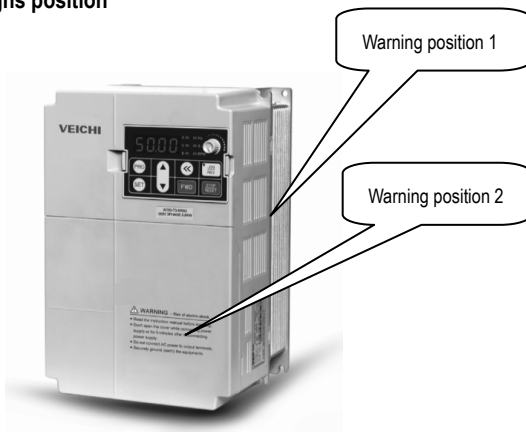

Drawing 1: Warning positions on crust of AC80C series inverter



## Operation requirement

Only Professional trained person are allowed to operate the equipment such as installation, wiring, running, maintain and etc. "Professional trained person" in this manual means the workers on this product must experience professional skill train, must be familiar with installation, wiring, running and maintain and can rightly deal with emergency cases in use.



## Safety guidance

Safety regulations and warning signs come for your security. They are measures to prevent the operator and machine system from damage. Pls carefully read this manual before using and strictly observe the regulations and warning signs while operating. Safety regulations and warning signs are classified into: routine regulation, transport and store regulation, installation and wiring regulation, running regulation, maintenance regulation, dismantlement and disposal regulation.

### ● Routine regulation

	<ul style="list-style-type: none"> <li>● This product carries dangerous voltage and controls driver machine with potential danger. If you don't abide by the regulations or requirements in this manual, there is danger of body injury even death and machine system damage.</li> <li>● Only qualified personnels are allowed to operate the equipment.this product. Before using, the operator must be familiar with all safety specifications and operation regulatons in this manual. Safe and stable work of the product is based on right operation and maintenance.</li> <li>● Do not wire while the power is conneted. Otherwise, there is danger of death for electric shock. Before wiring, inspection, maintenance, please cut power supply of all related equipments and ensure mains DC voltage in safe range. And please operate it after 5 mins.</li> </ul>
	<ul style="list-style-type: none"> <li>● Away from children and public.</li> <li>● Only used in application fields as maker stated. No use in equipments related to special fields such as emergency, succor, ship, medical treatment, avigation, nuclear and etc.</li> <li>● Unauthorized alteration or use of accessories which are not sold or recommended by the maker may cause faults.</li> </ul>
	<ul style="list-style-type: none"> <li>● Please make sure this manual is in the final user'hand before using.</li> <li>● Before installation and debugging pls carefully read and totally understand these safety regulation and warning signs.</li> </ul>

### ● Transport and store regulation

	<ul style="list-style-type: none"> <li>● Correct transport, store, installation and careful operation an maintenance are important for inverter safe operation.</li> </ul>
	<ul style="list-style-type: none"> <li>● In transport and store process, make sure the inverter is free from impact and vibration. It must be stored where is dry without corrosive air and conductive dust, and the temperature must be lower than 60℃.</li> </ul>

### ● Installation and wiring regulation

	<ul style="list-style-type: none"> <li>● Only professional trained person can operate it.</li> <li>● Power wire, motor wire and control wire should be all connected firmly. Earth must be reliable and earth resistance must be lower than 10Ω.</li> <li>● Before opening the inverter, please disconnect all related equipment power supply and make sure the mains DC voltage is in safe range and operate after 5mins.</li> <li>● Human body electrostatic will damage inner sensitive components seriously. Before operation, please follow ESD measures. Otherwise, there is danger of iverter damage.</li> <li>● Inverter output voltage is pulse wave. If components such as capacitor which improves power factor and pressure-sensitive resistance for anti-thunder and so on are installed at the output</li> </ul>
---	--

	<p>side, please dismantle them or change to input side.</p> <ul style="list-style-type: none"> <li>● No switch components such as breaker and contactor at the output side. (If there must be one, please make sure the output current is 0 while the switch acting).</li> </ul>
	<ul style="list-style-type: none"> <li>● The power supply cable and motor cable specifications must satisfy all conditions in table 3-7 3-8 .</li> </ul>

#### ● Run regulation

	<ul style="list-style-type: none"> <li>● Inverter runs at high voltage. So dangerous voltage is in some components inevitably.</li> <li>● No matter where the fault is, there is danger of serious accident, even human body injury what means dangerous malfunction possibility. So there must be additional external prevent measures or other safety devices, such as independent current limiting switch, machinery fence and so on.</li> </ul>
---	---

#### ● Maintenance regulation

	<ul style="list-style-type: none"> <li>● Only Veichi Electric co., ltd service department or its authorized service center or professional person trained and authorized by Veichi can maintain the products. They should be very familiar with the safety warning and operation gist in this manual.</li> <li>● Any defective components must be changed in time.</li> <li>● Before opening the inverter to repair please cut power supply of all related equipments and ensure mains DC voltage in safe range. And please do operation after 5 mins.</li> </ul>
---	---

#### ● Dismantlement and disposal regulation

	<ul style="list-style-type: none"> <li>● Packing case can be reused. Please keep them and reuse or send back to maker.</li> <li>● Dismantled metal components are retractable and can be reused.</li> <li>● Some components such as electrolytic capacitor are harmful to environment. Please dispose according to environmental protection departments.</li> </ul>
---	---

## 1.2 Technic criterion

Items		Criterion
Power input	Voltage,frequency	Single phase 220V 50/60Hz Three phase 380V 50/60Hz Three phase 220V 50/60Hz Three phase 660V 50/60Hz Three phase 1140V 50/60Hz
	Allowable fluctuations	Voltage:320V~440V; voltage unbalance rate:<3%; Frequency:±5% aberration rate: as IEC61800-2 required
	Inrush current	Lower than rated current
	Power factor	≥0.94(with DC reactor)
	Efficiency	≥96%
Output	Output voltage	Output under rated condition:3 phase, 0~input voltage, inaccuracy<5%
	Output frequency range	G type:0-320Hz
	Output frequency accuracy	Max frequency ±0.5%
	Overload capacity	G type:150% rated current/1 min, 180% rated current/10s, 200% rated current/0.5s
Main Control performance	Motor control mode	V/F without PG ,VC without PG, high-performance VC without PG, V/F with PG,VC with PG,high-performance VC with PG
	Modulate mode	Optimized SVPWM mode
	Carrier frequency	0.6~15.0kHz,randomized carrier-wave
	Speed range	VC without PG: rated load 1:100 VC with PG: rated load 1:1000
	Steady speed accuracy	VC without PG: ≤1% rated synchronized speed VC with PG: ≤0.02% rated synchronized speed
	Starting torque	Flux VC without PG: when 0.5Hz, 180% rated torque Flux VC with PG: when 0Hz, 200% rated torque
	Torque response	Flux VC without PG: ≤20ms Flux VC with PG: ≤10ms
	Torque control accuracy	Flux VC without PG: ±10% Flux VC with PG: ±5%
	Frequency accuracy	Digit setting:max frequency×±0.01% Analog setting:max frequency×±0.2%
	Frequency resolution	Digit setting:0.01Hz Analog setting:max frequency×0.05%
Basic functions	DC braking capacity	Starting frequency:0.00~50.00Hz Braking time:0.0~60.0s Braking current:0.0~150.0% rated current
	Torque upgrade capacity	Auto torque upgrade 0.0%~100.0% Manual torque ungrade 0.0%~30.0%

	V/F curve	5 modes: one user set V/F curve mode, one linearity torque characteristic curve and three drop torque characteristic curve (1.3power, 1.7power, 2.0 powers).	
	Acceleration/Deceleration curve	2 modes: One linear Acceleration/Deceleration and two S curve Acceleration/Deceleration. Four sets of Acceleration/Deceleration time unit 0.01s selectable longest time: 650.00s.	
	Rated output voltage	Rely on power supply voltage compensate function, while motor rated voltage is 100%, set it at the range of 50-100%(output can not over input volge).	
	Voltage auto-adjust	While power supply voltage fluctuates,it can auto-keep constant output voltage.	
	Energy-saving running	According to load situation, auto-optimize output voltage to save energy.	
	Auto-limit current	Auto-limit the current while running to prevent overcurrent break trouble.	
	Instant power off treatment	While instant power off, realize continual operation by bus voltage control.	
	Standard functions	PID control, speed track, power off restart, jump frequency, upper/lower frequency limit control, program operation, multi-steps speed, swing frequency running, RS485, analog output, frequency impulse output.	
	Frequency set channels	Keyboard digital set, keyboard potentionmeter, analog voltage terminal VS, analog voltage/current terminal AI,analog current terminal AS, communication given and multi channels terminal selection, master-slave channels combination.	
	Feedback input channel	Voltage terminal VS, voltage/current terminal AI ,current terminal AS, communication given, pulse input PUL.	
	Running command channel	Operation panel given, external terminal given, communication given.	
	Input command signal	Start, stop, FOR/REV, JOG, multi-step speed, free stop, reset, Acceleration/Deceleration time selection, frequency set channel selection, exterior fault alarm.	
	Exterior output signal	Two relay output, one collector output, 0~10V output,4~20mA output,frequency pulse output.	
Protection function		Overvoltage, undervoltage, current limit, overcurrent, overload, electric thermalrelay, overheat, overvoltage stall, data protection.	
Keyboard display	LED display	Single file 4 digital tube display	Can monitor one state variable
		Two file 5 digital tube display	Can monitor two state variables
	Parameter copy	Can upload or download function code information of inverter to realize fast parameter copy.	
	State monitor	Output frequency, given frequency, output current, input voltage, output voltage, motor speed, PID feedback, PID given value, module temperature, input/output terminal condition.	



	Fault alarm	Over-voltage, under-voltage, over-current, short circuit, open phase, overload, overheat, over-voltage speed lost, current limit, or data protection is destroyed; Fault running state; Fault history.
Environment	Install place	Indoor, altitude $\leq 1000\text{m}$ , no corrosive air or direct sunshine
	Temperature, humidity	$-10 \sim +40^{\circ}\text{C}$ $20\% \sim 90\% \text{RH}$ (no condensation)
	Vibration	Under $20\text{Hz} \leq 0.5\text{g}$
	Store temperature	$-25 \sim +65^{\circ}\text{C}$
	Installation	Hanging type, cabinet type
	Protection	IP20
	Cooling mode	Forced cooling

Table 1-1: Technic criterion

# Chapter 2 Before Use

## 2.1 Purchase inspection

Pls check whether any package is damaged while receiving the product you ordered. If the package is ok, pls open it and check the inverter. If damage caused in transport, it is not duty of Veichi company. But please contact Veichi or the transport company immediately.

After checking the product, please also check if the model is the one you ordered. The model of the product is on the nameplate "MODEL" column. If the model is not in accordance with your need, please contact the agent or the sales departments in our company.

## 2.2 Nameplate

### Nameplate position and content

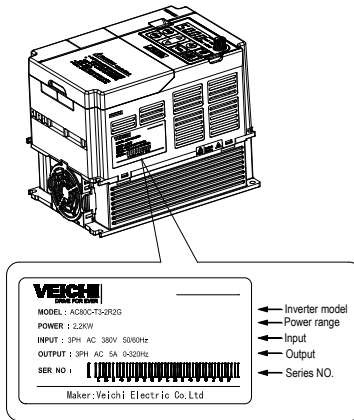

Drawing2-1: AC80C series inverter nameplate position

### Model explanation

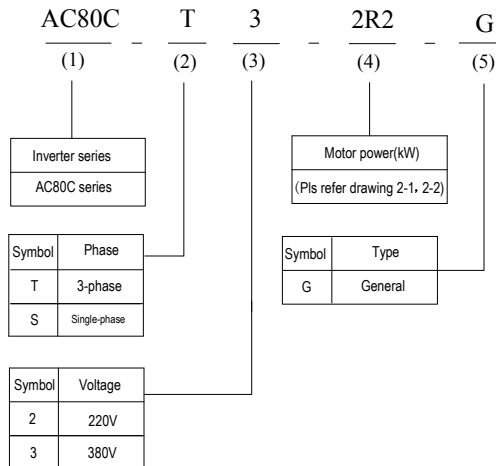

Drawing 2-2: AC80Cseries inverter nameplate meaning and naming rules

## 2.3 Standard models and rated parameters

### Single phase 220V

Model	Max adaptive motor	Rated current	Model	Max adaptive motor	Rated current
AC80C-S2-R40G	0.4kW	2.5A	AC80C-S2-1R5G	1.5kW	7A
AC80C-S2-R75G	0.75kW	4A	AC80C-S2-2R2G	2.2kW	10A

**Table 2-1: AC80C single phase 220V series inverter models and rated parameters**

### Three phase 380V

Model	Max adaptive motor	Rated current	Model	Max adaptive motor	Rated current
AC80C-T3-R75G	0.75kW	2.5A	AC80C-T3-110G	110kW	210A
AC80C-T3-1R5G	1.5kW	3.7A	AC80C-T3-132G	132kW	250A
AC80C-T3-2R2G	2.2kW	5A	AC80C-T3-160G	160kW	310A
AC80C-T3-004G	4kW	10A	AC80C-T3-185G	185kW	340A
AC80C-T3-5R5G	5.5kW	13A	AC80C-T3-200G	200kW	380A
AC80C-T3-7R5G	7.5kW	17A	AC80C-T3-220G	220kW	415A
AC80C-T3-011G	11kW	25A	AC80C-T3-250G	250kW	470A
AC80C-T3-015G	15kW	32A	AC80C-T3-280G	280kW	510A
AC80C-T3-018G	18.5kW	38A	AC80C-T3-315G	315kW	600A
AC80C-T3-022G	22kW	45A	AC80C-T3-355G	355kW	670A
AC80C-T3-030G	30kW	60A	AC80C-T3-400G	400kW	750A
AC80C-T3-037G	37kW	75A	AC80C-T3-450G	450kW	800A
AC80C-T3-045G	45kW	90A	AC80C-T3-500G	500kW	860A
AC80C-T3-055G	55kW	110A	AC80C-T3-560G	560kW	990A
AC80C-T3-075G	75kW	150A	AC80C-T3-630G	630kW	1100A
AC80C-T3-090G	90kW	180A	AC80C-T3-700G	700kW	1260A



**Table 2-2: AC80C three phase 380V series inverter models and rated parameters**

## Chapter 3 Installation and Wiring

### 3.1 Safety Precautions

This chapter explains the warnings for safe use and stable running of the product.

#### Cautions in use

	<ul style="list-style-type: none"> <li>● While stall the inverter in the closed cabinet, please build in cooling fan, air-condition or other cooling equipments to ensure the temperature at the air-in port below 40℃. So that the inverter can work safely and reliably.</li> </ul>
	<ul style="list-style-type: none"> <li>● While installing, please use cloth or paper cover the inverter to prevent metal dust, oil, water and others. And remove it carefully after working.</li> <li>● While operation, please follow the ESD regulations. Otherwise, the inverter may be damaged.</li> <li>● While multi inverters are installed in the same cabinet, enough space must be left for cooling fan.</li> <li>● Inverter can not work over rated range. Otherwise, the inverter may be damaged.</li> <li>● While transporting the inverter, please hold the firm case. If only hold the pre-cover, there is danger of inverter main body falling, injury or inverter damage.</li> </ul>

#### Cautions in use motor

	<ul style="list-style-type: none"> <li>● Different motor has different max allowable running speed. Motor can not run over the max allowable running speed.</li> <li>● While inverter is running at low speed, the motor auto-cool effect is seriously worse. If motor runs at low speed for long time, it will be damaged for overheat. If needed, please use special motor for inverter.</li> <li>● While constant speed machinery runs at unconstant speed, there maybe sympathetic vibration. Please install vibration-proof rubber under motor rack or use jumping frequency control function.</li> <li>● While using frequency inverter or working frequency power supply to drive, the torque characteristic are different. Please do confirm the torque characteristic of the equipment connected.</li> <li>● The rated current of shift gear motor is different from that of standard motor. Please confirm it and choose the right frequency inverter. Moreover, please do switch the pole while the inverter input current is 0. Otherwise it may bring inverter protection or damage.</li> <li>● The rated current of diving motor is higher than that of standard motor, please confirm it and choose the right inverter.</li> <li>● While the wire between motor and inverter is long, the max torque of the motor will reduce for voltage drop. So please use thick cable while the distance between the motor and the inverter is long.</li> </ul>
--	--

### 3.2 Treatment for inverter after longtime store

If the inverter store time is over one year, you must precharge the aluminium capacitor in the inverter again and install the inverter after the aluminium capacitor characteristic recovering. For the specific method, please follow the grads in belowing chart and give corresponding proportional voltage for every grad more than 30 mins while the inverter is no-load.

If the input voltage of one grad is at the action critical point of contactor, fan or other equipments, please increase or reduce the corresponding input voltage for the grad to avoid any component working under critical state.

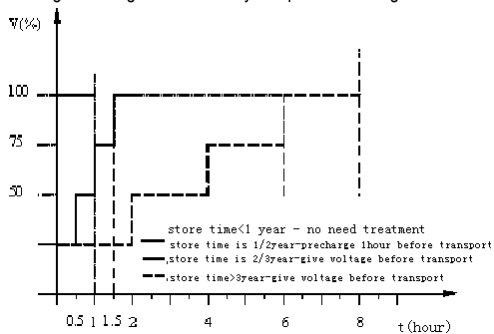

Chart 3-1: treatment for inverter after longtime store

### 3.3 Inverter stable running environment

Installation environment is very important to the best use of this product for long time. Pls install this product in the environment as the following chart requirement.

Environment	Requirement
Install place	Indoor without direct sunshine
Install temperature	-10 ~ +40°C (hanging type) -10 ~ +45°C (cabinet type)
Store temperature	-20 ~ +60°C
Humidity	<95%RH, no condensation
Surrounding	Please install the inverter in place as follows: <ul style="list-style-type: none"> <li>● Place without oil mist, corrosive gases, flammable gas, dust or etc.</li> <li>● Place without metal dust, oil, water or etc into inverter (please do not install inverter on flammable material such as food and etc).</li> <li>● Place without radioactive material or flammable material.</li> <li>● Place without poisonous gases or liquid.</li> <li>● Place with very little salification erosion.</li> <li>● Place without direct sunshine.</li> </ul>
Altitude	<1000m
Vibration	<10~20Hz:9.8m/s <sup>2</sup> <20~55Hz:5.9m/s <sup>2</sup>
Installation and cooling	<ul style="list-style-type: none"> <li>● Inverter can not be installed horizontally must be installed vertically.</li> <li>● Please independently install high heating equipments such as braking resistor and etc which can not be installed in the same cabinet with inverter, installed at the air-in port of the inverter is strictly prohibited.</li> </ul>

Chart 3-1:AC80C series inverter running environment condition

- In order to improve the product stability, pls do not use the inverter where temperature changes sharply. While using in closed space such as control cabinet, please use cooling fan or air-condition to cool inverter to avoid temperature over limit range. Please also prevent inverter from freeze, too low temperature may cause components freeze fault.
- Derate according to the chart while over temperature limit.

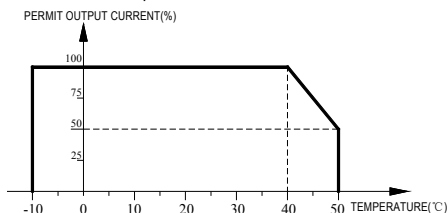

**Chart 3-2:AC80C series inverter derating curve while over permit temperature**

- Derate according to the chart while over altitude limit.

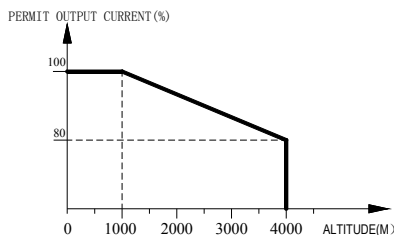



**Chart 3-3:AC80C series inverter derating curve while over permit altitude**

### 3.4 EMI Protection

The inverter is designed to be used in industrial environment with strong electromagnetic interference. Generally speaking, if the installation quality is good, it is ensured that the inverter can work safely without fault. Please install the inverter according to the following rules to ensure stable running and avoid electromagnetic interference impact.

- Ensure that all equipments in the cabinet have been connected reliably to the common Y-type earth point or earth bus with thick and short cable. The motor earth should be as close as possible. Please do not connect the motor case to the inverter earth terminal or the protective area of control system.
- Ensure that all equipments connected to the inverter have been reliably connected to the same earth net or Y-type earth point with thick and short cable.
- The conductor has better to be flat and with multi core, what has lower resistance at high frequency.
- The cutting terminal should be as soigne as possible. Unshielded wire section must be as short as possible.
- In control cable wiring, it should be as far from the power supply cable and motor cable as possible. And independent cable trough should be used. While the control cable must cross to the power supply cable or motor cable, it should be 90° vertical cross.
- Ensure that the contactor in the cabinet has wave surge suppresser. Or'R-C' damping circuit is connected to the winding of AC contactor. Voltage dependent resistor corresponding to the winding voltage is used. And freewheel diode or components such as voltage dependent resistor corresponding to the winding voltage are connected to DC contactor. It is very important while contactor, controlled by output relay of inverter, acts frequently.
- Cable connected to motor should be shielded cable or armoured cable. The two barriers are earthed reliably by cable grounding card.
- Build noise filters at the input side to reduce electromagnetic interference from other equipments at the power grid side. The noise filter should be as close to the inverter power input terminal as possible. Meantime, the filter must earth reliably as the inverter.

- Build noise filters at the output side to reduce radio interference and inductive disturbance. The noise filter must be as close to the inverter output terminal as possible. Meantime, the filter must earth reliably as the inverter.
- Anytime, control circuit wire should be shielded cable.
- Add zero phase reactor in power supply wire near inverter input terminal and add zero phase reactor in the motor wire near inverter output terminal to reduce electromagnetic interference to the inverter efficiently.
- Earthing Right and reliable earthing is the basic condition of safe and reliable running of the product. For right earthing, please read the following notice carefully.

	<ul style="list-style-type: none"> <li>● In order to avoid electric shock, earthing cable should be the size as electric equipment technic standard required and cable length should be as short as possible. Otherwise, inverter leakage current will cause unstable potential of the earthing terminal which is far from the earthing point, and electric shock accident will happen frequently.</li> <li>● Earth terminal must be earthing. Earth resistance must be below 10Ω. Otherwise, there is danger of death.</li> </ul>
	<ul style="list-style-type: none"> <li>● Please do not share earth cable with welder or other big current/pulse power equipment. Otherwise, inverter will act abnormally.</li> <li>● While multi inverters are used at the same time, please do not wind the earth wire to loop-type. Otherwise, inverter will act abnormally.</li> </ul>

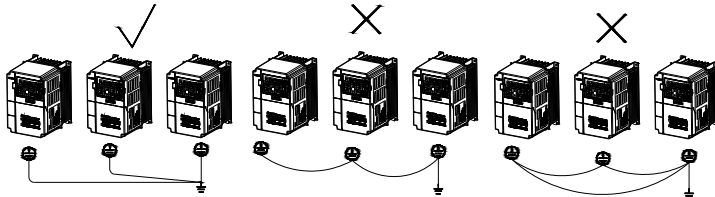

Chart 3-4: multi AC80C series inverters united earthing

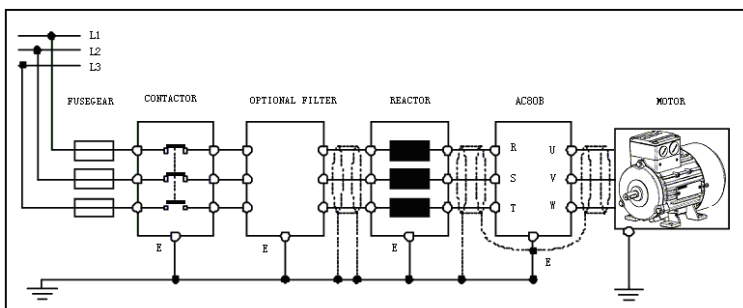
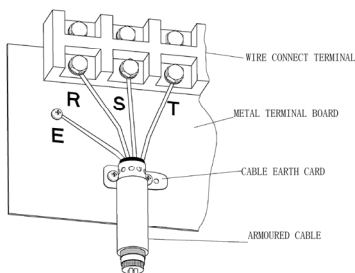

Chart 3-5: AC80C series inverter system earthing

Remark: motor must earth as close as possible. Motor case can not be connected to the inner earth terminal of the inverter. It also can not share the earth net with the control system.

Shield of inverter power cable, motor cable, control cable Cable

Shielding layer (reticulate/armoured) should be wound reliably by cable earth card and fix to inverter earth piece by bolt. Please refer to the following chart.



**Chart 3-6: Cable earth card for cables earthing**

- Corresponding relationship between inverter/motor cable length and carrier frequency.

While cable distance between inverter and motor is long (especially low frequency output), cable voltage drop will make motor torque reduce. Further more, cable HF leakage current will increase. Then inverter output current will increase, that will cause inverter over-current trip. The current detection accuracy and running stability will be impacted. Please follow as below chart to adjust carrier frequency according to the cable length. While the cable distance is over 100m, please adopt distributed capacity reduce measure (Such as "no metal conductor covers cable", "wire each phase cable apart" and so on).

Cable length	<20m	20~50m	50~100m	>100m
Carrier frequency	0.6~16kHz	0.6~8kHz	0.6~4kHz	0.6~2kHz

**Chart 3-2: Corresponding relationship between inverter/motor cable length and carrier frequency**



## 3.5 Machinery installation

### Installation notice and related requirement

- AC80C inverter components

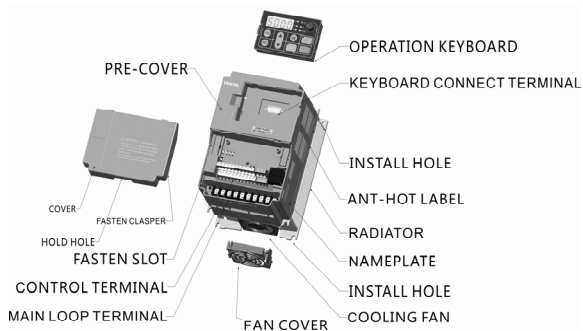

Chart 3-7: AC80C series inverter components

- Installation direction

To prevent inverter cooling effect reducing, please do install the inverter vertically.

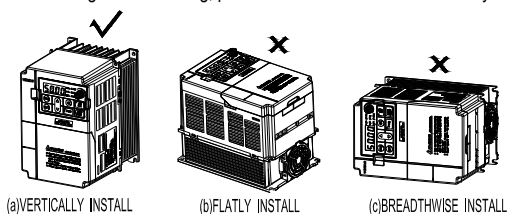

Chart 3-8: AC80C series inverter installation direction

- Installation space

Single machine installation: to ensure enough ventilation and wiring space for inverter cooling, please follow installation conditions as follows. The back of the inverter should stick to the wall. So that the surrounding air of radiator can flow freely to ensure the cooling effect.

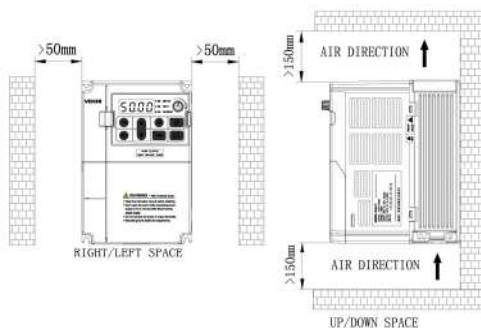

Chart 3-9: Single AC80C series inverter installation space

Multi inverters paratactic installation: while installing multi inverters in cabinet, please ensure installation space as follows.

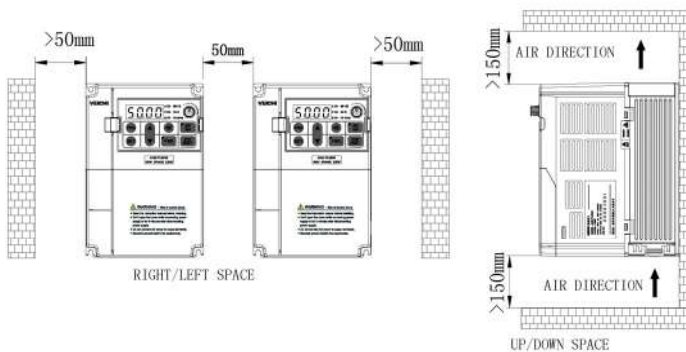
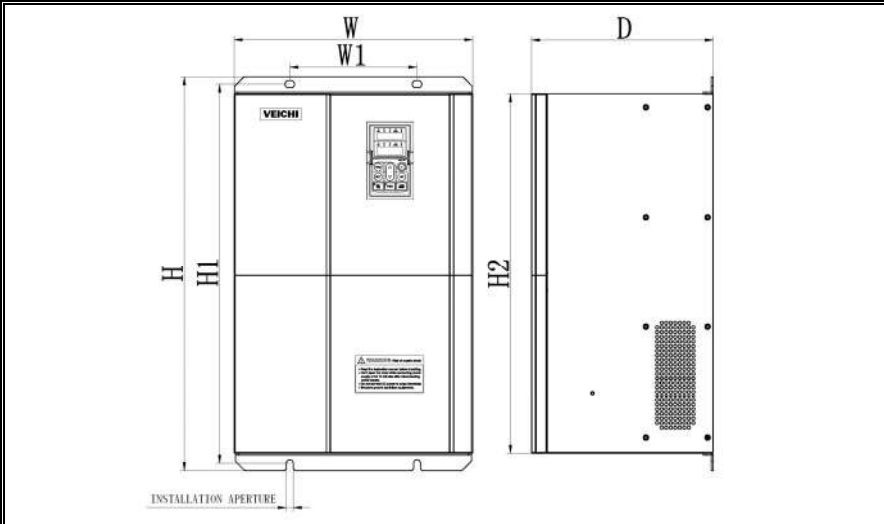

Chart 3-10: Multi AC80C series inverters paratactic installation space requirement

## Dimension of inverter and keyboard

MODEL	Front View Dimensions				Rear View Dimensions		INSTALLATION APERTURE
	W	W1	H	H1	D	D1	
AC80C-S2-R40G	122	112	182	171	154.5	145	φ5
AC80C-S2-R75G							
AC80C-S2-1R5G							
AC80C-S2-2R2G	159	147.2	246	236	157.5	148	φ5.5
AC80C-T3-R75G	122	112	182	171	154.5	145	φ5
AC80C-T3-1R5G							
AC80C-T3-2R2G							
AC80C-T3-004G	159	147.2	246	236	157.5	148	φ5.5
AC80C-T3-5R5G							
AC80C-T3-7R5G	195	179	291	275	167.5	158	φ7
AC80C-T3-011G							
AC80C-T3-015G	230	208	330	315	200	190	φ7
AC80C-T3-018G							
AC80C-T3-022G							



MODEL	W	H	D	H2	W1	H1	INSTALLATION APERTURE
AC80C-T3-030G	255	410	225	370	180	395	φ7
AC80C-T3-037G	305	570	260	522	180	550	φ9
AC80C-T3-045G							
AC80C-T3-055G							
AC80C-T3-075G	380	620	290	564	240	595	φ11
AC80C-T3-093G							
AC80C-T3-110G							

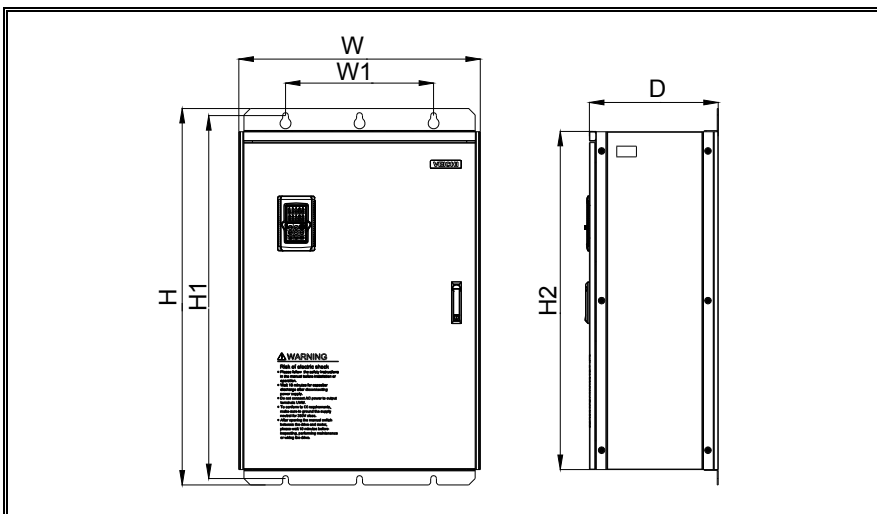

MODEL	W	H	D	H2	W1	H1	INSTALLATION APERTURE
AC80C-T3-132G	500	780	340	708	350	755	φ11
AC80C-T3-160G	650	1060	400	950	400	1023	φ16
AC80C-T3-185G							
AC80C-T3-200G							
AC80C-T3-220G	750	1170	400	1050	460	1128	φ18
AC80C-T3-250G							
AC80C-T3-280G							
AC80C-T3-315G	850	1280	450	1150	550	1236	φ20
AC80C-T3-355G							
AC80C-T3-400G							

**Notice: No DC reactor inside**

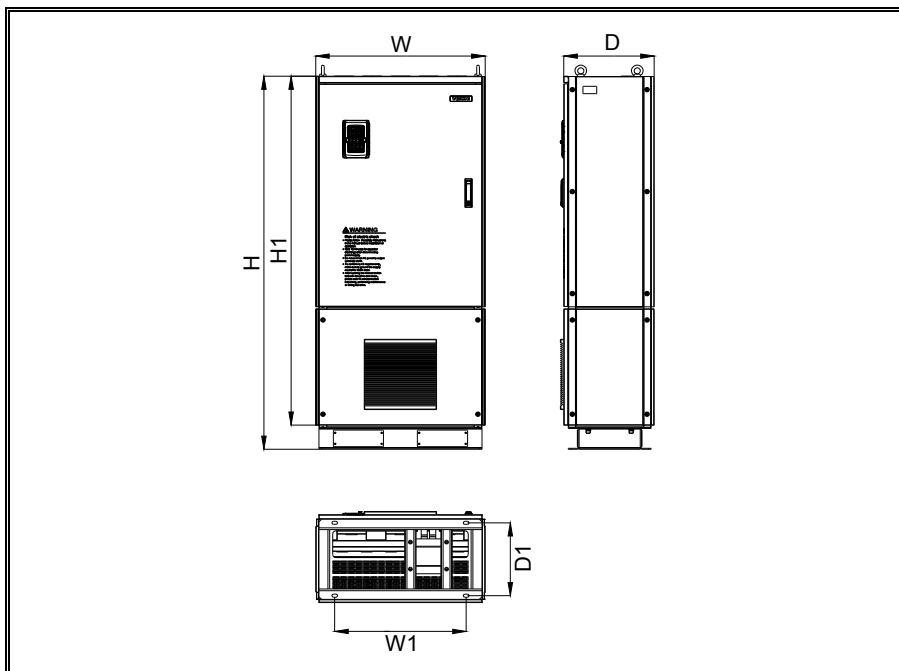

MODEL	W	H	D	H1	W1	D1	INSTALLATION APERTURE
AC80C-T3-160GD	650	1600	400	1500	492	332	φ14
AC80C-T3-185GD							
AC80C-T3-200GD							
AC80C-T3-220GD	750	1700	400	1600	582	332	φ14
AC80C-T3-250GD							
AC80C-T3-280GD							
AC80C-T3-315GD	850	1800	450	1700	622	382	φ14
AC80C-T3-355GD							
AC80C-T3-400GD							

**Notice: DC reactor inside**

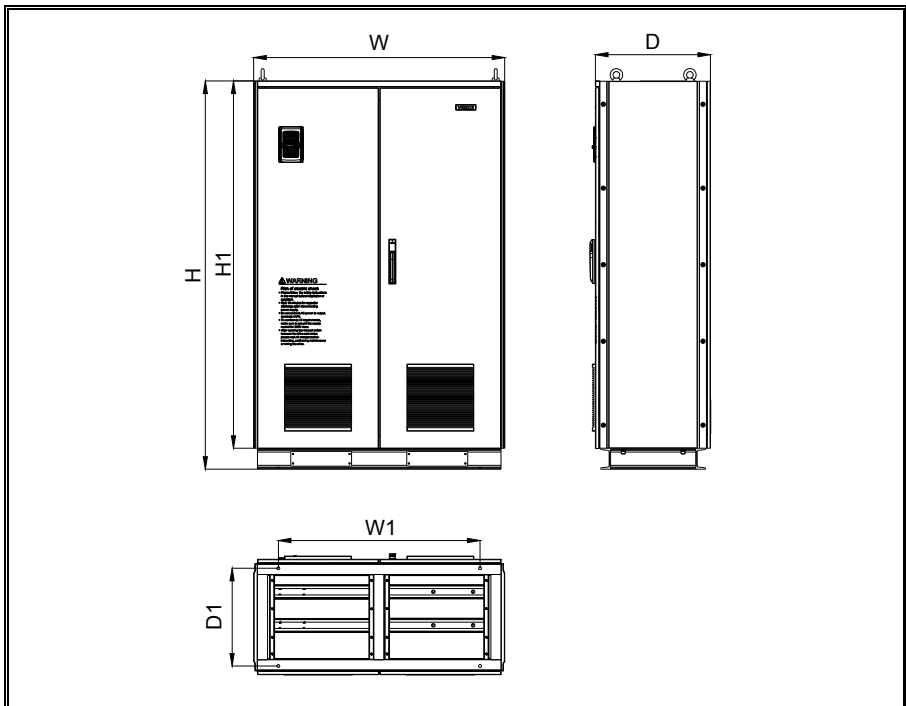

MODEL	W	H	D	H1	W1	D1	INSTALLATION APERTURE
AC80C-T3-450G	1200	1850	550	1750	960	466	φ14
AC80C-T3-500G							
AC80C-T3-560G							

Chart 3-3: AC80C series inverter dimension

**Keyboard dimension**

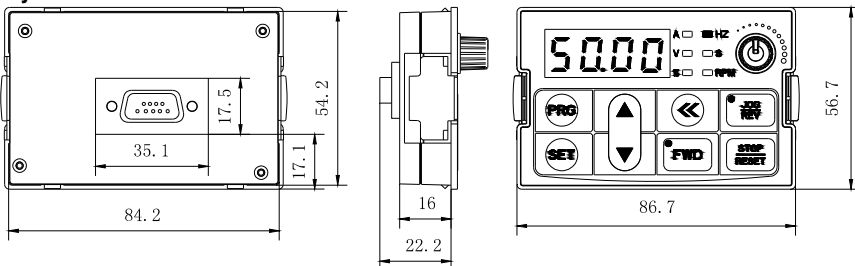

**Chart 3-11:AC80C series inverter 1 line LED keyboard dimension**

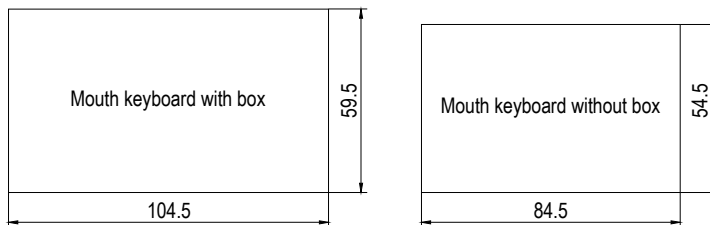

**Chart 3-12:AC80C series inverter mouth for 1 line LED keyboard dimension**

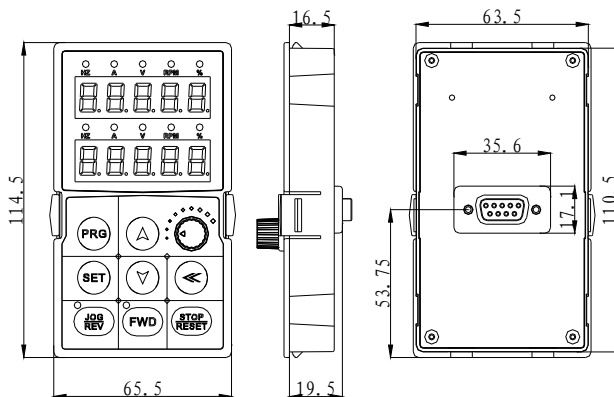

**Chart 3-13:AC80C series inverter 2 line LED keyboard dimension**

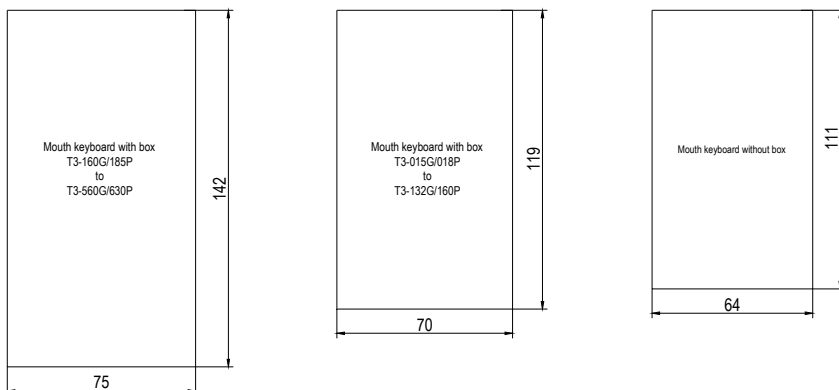
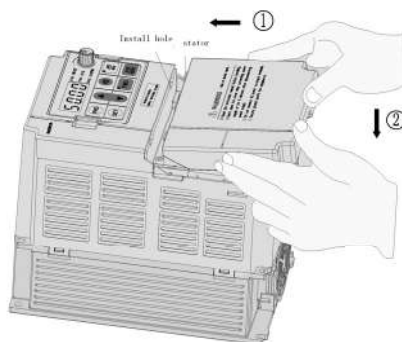

Chart 3-14:AC80C series inverter mouth for 2 line LED keyboard dimension

### Dismantle and install tail-hood

**Installation:** First the tail-hood upwardly inclines around 15 degrees and inserts the top fixed flat into the fixed hole in the front cover. Then slightly press the tail-hood downward. While you hear "Ka", it means that the tail-hood is into the place.

#### Chart 3-15:AC80C series inverter tail-hood installation



**Dismantlement:** At the tail of the frequency inverter, there is a special dismantlement hole design. Put your finger into the hole, upwardly pull the cover with a little force until the buckle between the tail-hood and the crust tear off, and then remove the tail-hood down.

#### Chart 3-16:AC80C series inverter tail-hood dismantlement

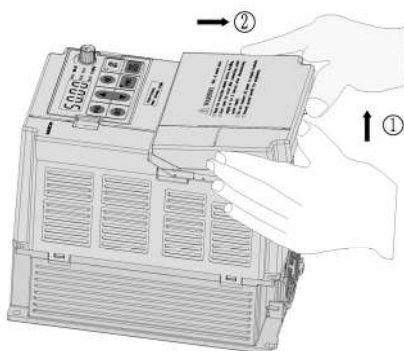



## Dismantle and install keyboard

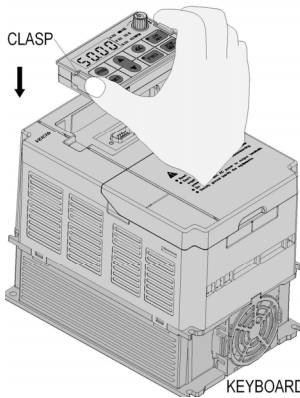

KEYBOARD INSTALLATION

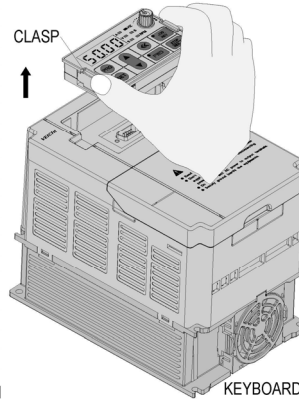



KEYBOARD DISMANTLEMENT

Chart 3-17:AC80C series inverter keyboard installation and dismantlement

## 3.6 Electric installation

This chapter explains the regulations that users have to obey to ensure safe use, best performance and reliable running.

### Safety attention

	<ul style="list-style-type: none"> <li>● Must earth reliably while inverter is running. Otherwise there is danger of casualty and unstable inverter performance.</li> <li>● To ensure safe running, only trained professional person can do installation and wiring job.</li> <li>● No operation under power connected state. Otherwise there is danger of electric shock even death.</li> <li>● Before operation, please cut all related equipments power, ensure that the main circuit DC current has dropped to safe range. And please operate after 5 mins.</li> </ul>
	<ul style="list-style-type: none"> <li>● Control cable, power cable and motor cable must be separated. They can not be in the same cable trough or cable rack.</li> <li>● This equipment can only be used as the maker states. Please consult Veichi while using in special case.</li> </ul>
	<ul style="list-style-type: none"> <li>● No insulation test for the inverter or the related cable by HV insulation test equipment.</li> <li>● If the inverter or the peripheral equipment (filer, reactor and etc) needs insulation test, firstly 500V megohmmeter should be used to test the insulation resistance which should not be lower than 4MΩ.</li> </ul>

## Standard diagram

## ● Standard diagram

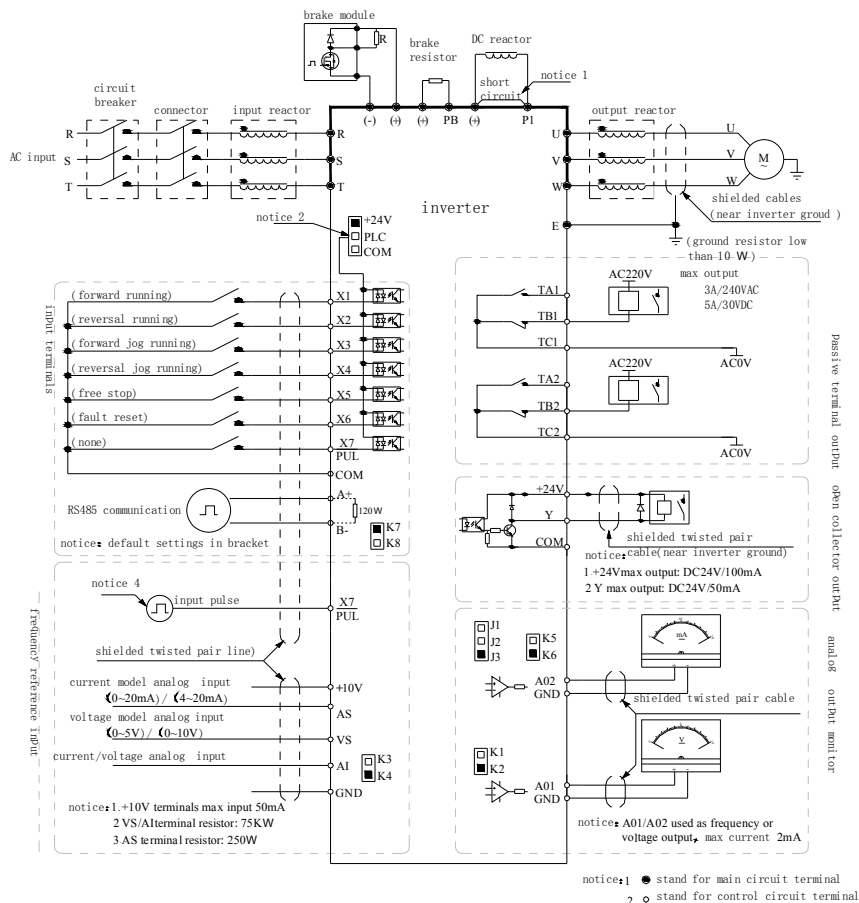

Chart 3-18: AC80C series inverter standard diagram

Note:

1. While install DC reactor, be sure to dismantle the short connector between terminal P1 and (+) .
2. NPN or PNP transistor signal can be selected as input of multi-function input terminal (X1~X7/PUL) . Inverter built-in power supply (+24V terminal) or external power supply (PLC terminal) can be choosed as bias voltage. Factory setting '+24V' short connect with 'PLC'.
3. Analog monitor output is special output of meters such as frequency meter, current meter, voltage meter and etc. It can not be used for control operations such as feedback control.
4. As there are multi pulse styles, please refer to the line connect mode description details.

- Auxiliary terminal output capacity

Terminal	Function definition	Max output
+10V	10V auxiliary power supply output, constitutes loop with GND.	50mA
A01/A02	Analog monitor output, constitutes loop with GND.	As frequency, voltage signal, max output 2mA
+24V	24V auxiliary power supply output, constitutes loop with COM.	100mA
Y	Collector open circuit output, can set the action-object by programme.	DC24V/50mA
TA/TB/TC	Passive connector output, can set the action-object by programme.	3A/240VAC 5A/30VDC

Chart 3-4: AC80C series inverter auxiliary terminals output capacity

- Switch terminals connection function specification

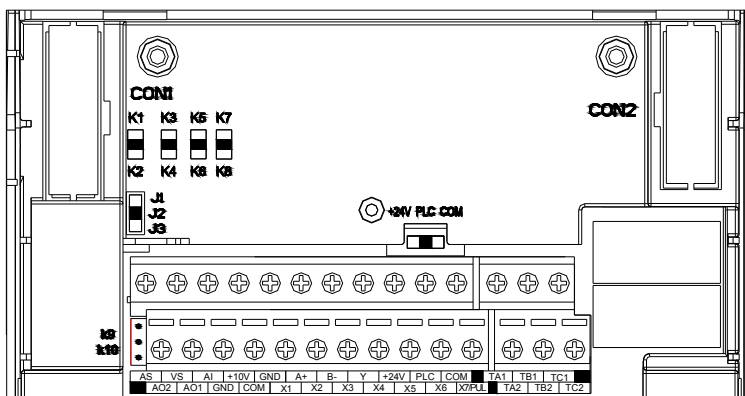

Switch terminal	Selectable position	Function specification
S1	K1	AO1: 0~20mA or 4~20mA current output
	K2	AO1: 0~10V voltage output
S2	K3	AI: 0~20mA or 4~20mA input current
	K4	AI: 0~10V input voltage
S3	K5	AO2: 0.0~50kHz (J1 on), open collector circuit output
	K6	AO2: 0.0~50kHz (J1 on), active source output
S4	K7	RS485: connect with 120Ω resistor
	K8	RS485: connect without 120Ω resistor
S5	J1	AO2: 0.0~50kHz frequency output
	J2	AO2: 0~20mA or 4~20mA current output

	J3	AO2:0~10V voltage output
S6	+24V	Short +24V terminal and PLC terminal
	PLC	PLC terminal receives external power input,details in drawing 3-22,3-23
	COM	Short PLC terminal and COM terminal
	K9	Disconnect GND terminal and PE discharge loop
S7	K10	Connect GND terminal and PE discharge loop

Chart 3-5: AC80C series inverter switch terminal connection function specification

**Main circuit terminals**

- Main circuit terminals array and definition

Power under 22kW main circuit terminals array:



Power 30kW main circuit terminals array:(No PB terminal in standard machine)

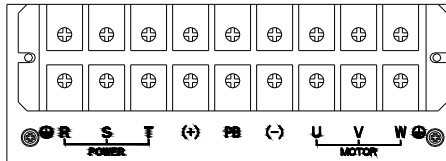

Power 37~110kW main circuit terminals array:

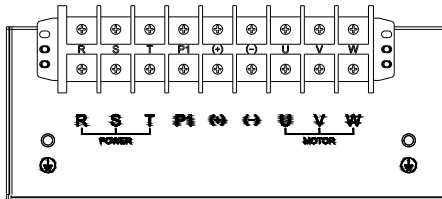

Power 132kW main circuit terminals array:

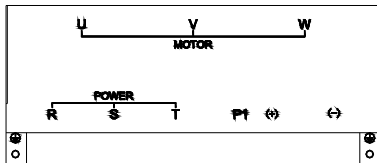

Power 160~560kW main circuit terminals array:

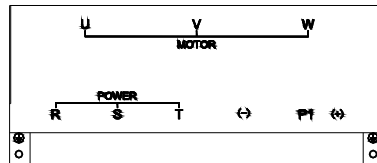

Terminal	Name	Function definition
(-)	DC power terminal	DC power output, (-) means DC bus cathode, (+) means DC bus anode, used for external braking unit.
(+)		

(+)	Braking resistance terminal	Used for external braking resistance to realize quick stop.
PB		
P1	DC reactor terminal	Used for external DC reactor.
(+)		
R	Inverter input terminal	Used to connect 3-phase AC power supply.
S		
T		
U	Inverter output terminal	Used to connect the motor.
V		
W		
⊕	Earth	Earth terminal, earth resistance<10Ω
E		

Chart 3-6:AC80C series inverter main circuit terminals array and definition

## ● 3-phase 380V machine main circuit wiring

Model	Main circuit terminals screw specifications	Suggested fixed moment (N·m)	Suggested Copper-core cable specification mm <sup>2</sup>
AC80C-T3-R75G	M4	1.2--1.5	1.5mm <sup>2</sup> (14)
AC80C-T3-1R5G	M4	1.2--1.5	2.5 mm <sup>2</sup> (12)
AC80C-T3-2R2G	M4	1.2--1.5	2.5 mm <sup>2</sup> (12)
AC80C-T3-004G	M4	1.2--1.5	4 mm <sup>2</sup> (10)
AC80C-T3-5R5G	M4	1.2--1.5	6 mm <sup>2</sup> (9)
AC80C-T3-7R5G	M5	2--2.5	6 mm <sup>2</sup> (9)
AC80C-T3-011G	M5	2--2.5	10 mm <sup>2</sup> (7)
AC80C-T3-015G	M6	4--6	10 mm <sup>2</sup> (7)
AC80C-T3-018G	M6	4--6	16 mm <sup>2</sup> (5)
AC80C-T3-022G	M6	4--6	16 mm <sup>2</sup> (5)
AC80C-T3-030G	M8	8--10	25 mm <sup>2</sup> (3)
AC80C-T3-037G	M8	8--10	25 mm <sup>2</sup> (3)
AC80C-T3-045G	M8	8--10	35 mm <sup>2</sup> (2)
AC80C-T3-055G	M10	11--13	35 mm <sup>2</sup> (2)
AC80C-T3-075G	M10	11--13	50 mm <sup>2</sup> (1)
AC80C-T3-093G	M10	11--13	50 mm <sup>2</sup> (1/0)
AC80C-T3-110G	M10	11--13	70 mm <sup>2</sup> (2/0)
AC80C-T3-132G	M10	11--13	95 mm <sup>2</sup> (3/0)
AC80C-T3-160G	M12	14--16	95 mm <sup>2</sup> (4/0)
AC80C-T3-185G	M12	14--16	120mm <sup>2</sup>
AC80C-T3-200G	M12	14--16	150mm <sup>2</sup>
AC80C-T3-220G	M12	14--16	150mm <sup>2</sup>
AC80C-T3-250G	M12	14--16	185mm <sup>2</sup>

AC80C-T3-280G	M12	14--16	185mm <sup>2</sup>
AC80C-T3-315G	M16	20--23	240mm <sup>2</sup>
AC80C-T3-355G	M16	20--23	240mm <sup>2</sup>
AC80C-T3-400G	M16	20--23	300mm <sup>2</sup>
AC80C-T3-450G	M16	20--23	400mm <sup>2</sup>
AC80C-T3-500G	M16	20--23	400mm <sup>2</sup>
AC80C-T3-560G	M16	20--23	500mm <sup>2</sup>

Note: Here we suggest to use copper joins as mains electric connectors of machine over 185KW. Pls refer the cut section area above.

**Chart 3-7: Suggested cable diameter and fixed moment 3-phase 380V machine main circuit**

## ● Single-phase 220V machine main circuit wiring

Model	Main circuit terminals screw specifications	Suggested fixed moment (N·m)	Suggested Copper-core cable specification mm <sup>2</sup>
AC80C-S2-R40G	M4	1.2--1.5	1.5mm <sup>2</sup> (14)
AC80C-S2-R75G	M4	1.2--1.5	2.5mm <sup>2</sup> (12)
AC80C-S2-1R5G	M4	1.2--1.5	2.5mm <sup>2</sup> (12)
AC80C-S2-2R2G	M4	1.2--1.5	4mm <sup>2</sup> (10)

**Chart 3-8: Suggested cable diameter and fixed moment single-phase 220V machine main circuit**

## ● Suggested main circuit components specification

Model	Contactur specification	Breaker specification	DC reactor	Input filter	Output filter
AC80C-T3-R75G	10A	10A	-----	NFI-005	NFO-010
AC80C-T3-1R5G	10A	10A	-----	NFI-005	NFO-010
AC80C-T3-2R2G	16A	15A	-----	NFI-010	NFO-010
AC80C-T3-004G	16A	20A	-----	NFI-010	NFO-010
AC80C-T3-5R5G	25A	20A	-----	NFI-020	NFO-020
AC80C-T3-7R5G	25A	30A	-----	NFI-020	NFO-020
AC80C-T3-011G	32A	40A	-----	NFI-036	NFO-036
AC80C-T3-015G	40A	50A	-----	NFI-036	NFO-036
AC80C-T3-018G	50A	60A	-----	NFI-050	NFO-050
AC80C-T3-022G	50A	75A	DCL-50	NFI-050	NFO-050
AC80C-T3-030G	63A	100A	DCL-80	NFI-080	NFO-080
AC80C-T3-037G	80A	125A	DCL-100	NFI-100	NFO-100
AC80C-T3-045G	100A	150A	DCL-110	NFI-100	NFO-100
AC80C-T3-055G	125A	175A	DCL-125	NFI-150	NFO-150
AC80C-T3-075G	160A	200A	DCL-150	NFI-150	NFO-150
AC80C-T3-093G	220A	250A	DCL-200	NFI-200	NFO-300
AC80C-T3-110G	220A	300A	DCL-200	NFI-200	NFO-300
AC80C-T3-132G	250A	400A	DCL-300	NFI-300	NFO-300

AC80C-T3-160G	300A	500A	DCL-300	NFI-300	NFO-300
AC80C-T3-185G	400A	600A	DCL-400	NFI-400	NFO-400
AC80C-T3-200G	400A	700A	DCL-400	NFI-400	NFO-400
AC80C-T3-220G	630A	800A	DCL-500	NFI-600	NFO-600
AC80C-T3-250G	630A	1000A	DCL-600	NFI-600	NFO-600
AC80C-T3-280G	630A	1200A	DCL-600	NFI-600	NFO-600
AC80C-T3-315G	630A	1200A	DCL-800	-----	-----
AC80C-T3-355G	800A	1400A	DCL-800	-----	-----
AC80C-T3-400G	1000A	1600A	DCL-1000	-----	-----
AC80C-T3-450G	1000A	2000A	DCL-1000	-----	-----
AC80C-T3-500G	1000A	2000A	DCL-1200	-----	-----
AC80C-T3-560G	-----	2000A	DCL-1200	-----	-----

Note: For DC reactor, input filter, output filter and other components specification details and circuit mode, please refer chapter 7 "peripheral equipments and options".

Chart 3-9: Suggested mains fittings for 3-phase 380V machine

### Control loop terminals

- Control loop terminals array:

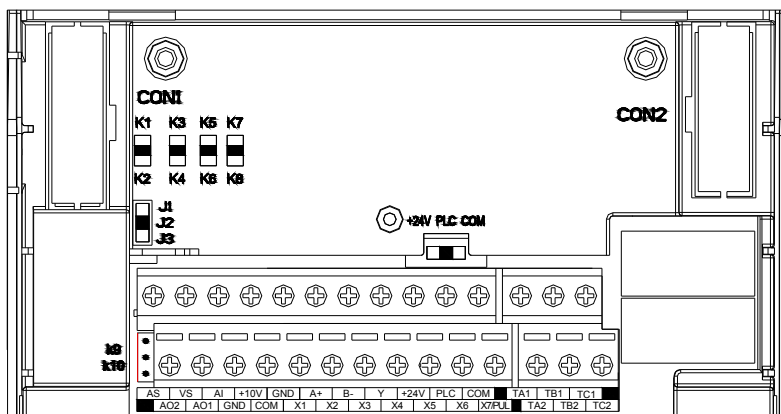

Sort	Terminal	Name	Function define
Power	+10V-GND	+10V power supply	Supply +10V power, max output current,50 mA ,usually supply for potentiometer, resistance of potentiometer range: 1KΩ~5KΩ
	+24V-COM	+24V power supply	Supply +24V power, usually used for digital input/output terminals and external sensors,max output current: 100 mA
	PLC	Common terminal	Connect with +24V terminal in factory default. When using exterior signal to drive X1-X7/PUL,PLC must be connected with external

			power, and disconnected with +24V terminal (details in drawing 3-22, 3-23)
Analog input	AS-GND	Current analog input	1. input current range: DC 0mA~20mA 2. input resistance: 500Ω
	VS-GND	Voltage analog input	1. input voltage range: DC 0V~10V 2. input resistance: 75 KΩ
	AI-GND	Voltage or current analog input	1. input range: DC 0V~10V/0mA~20mA, related to switch S2 (details in drawing 3-5) 2. voltage input resistance: 75 KΩ 3. current input resistance: 500Ω
Digital input	X1-PLC	Multi-function input terminal1	Separate by optocoupler, compatible bipolar input 1. input resistance: 4.4 KΩ 2. voltage input range: 10~30V
	X2-PLC	Multi-function input terminal1	
	X3-PLC	Multi-function input terminal1	
	X4-PLC	Multi-function input terminal1	
	X5-PLC	Multi-function input terminal1	
	X6-PLC	Multi-function input terminal1	
	X7/PUL-PLC	Multi-function or high-speed frequency input terminal	Can be also used for high-speed frequency input except other functions like X1-X6 1. Separate by optocoupler, compatible bipolar input, max input frequency: 100KHZ 2. input resistance: 1.5KΩ 3. pulse frequency input voltage range: 10~30V
Analog output	AO1-GND	Analog output 1	Voltage or current output decided by switch S1 (details in drawing 3-5) 1. output voltage range: DC 0V~10V 2. output current range: DC 0mA~20mA
	AO2-GND	Analog output 2	Voltage, current or high-speed frequency output decided by switch S5 (details in drawing 3-5) 1. output voltage range: DC 0V~10V 2. output current range: DC 0mA~20mA 3. pulse frequency output range: 0~50KHZ When select pulse frequency output, you need to set F3.27=3, active source or open collector circuit output decided by switch S3 (details in drawing 3-5)
Digital output	Y-COM	Digital output1	Separate by optocoupler, open collector circuit output 1. output voltage range: DC 0V~30V 2. output current range: DC 0mA~50mA



relay output	TA1-TC1	Normal close terminal 1	Max load: 240VAC, 3A 30VDC, 5A
	TB1-TC1	Normal open terminal 1	
	TA2-TC2	Normal close terminal 2	
	TB2-TC2	Normal open terminal 2	
Communication terminal	A+	Communication terminal A+	RS485 communication ports Whether connect with 120Ω terminal resistance or not is decided by switch S4 (details refer to chart 3-5)
	B-	Communication terminal B-	

Chart 3-10: AC80C series inverter control loop terminals array and definition

- Control loop terminal wiring specification

Terminal	Bolt specification (mm)	Fixed moment (N·m)	Cable specification (mm <sup>2</sup> )	Cable type
A+ B-	M2.5	0.4~0.6	0.75	Twisted-pair shielded cable
+10V GND A01 A02 AS VS AI	M2.5	0.4~0.6	0.75	Twisted-pair shielded cable
+24V COM Y TA 1 TB 1 TC1 PLC X1 X2 X3 X4 X5 X6 X7/PUL	M2.5	0.4~0.6	0.75	Shielded cable

Chart 3-11: Control loop terminal wiring specification

### Braking unit (braking resistance) connection

- Braking resistance connection of machine below 22KW

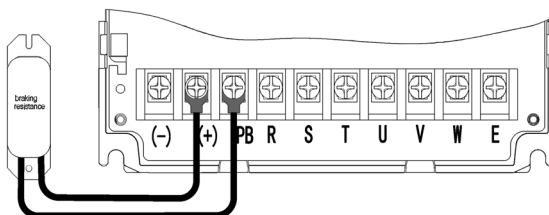

Figure 3-19: Braking resistance connection of AC80C series inverter below 22KW

- Braking resistance connection of 30kw machine (optional braking unit inside)

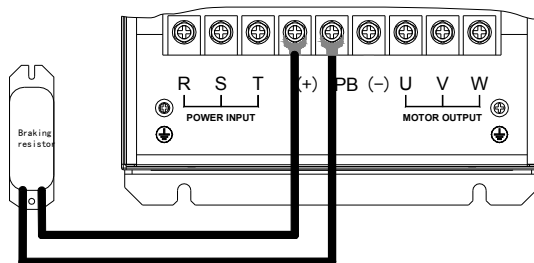

Figure 3-20: Braking resistance connection of AC80C series inverter of 30kw

- Braking unit connection of machine above 37KW

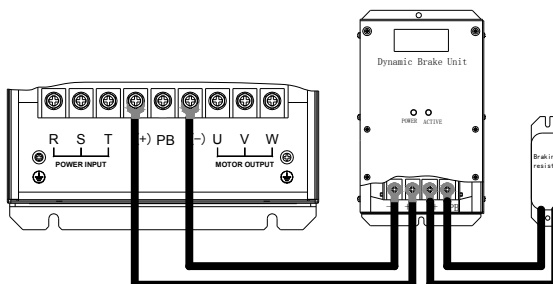

Figure 3-21: Braking resistance connection of AC80C series inverter above 37KW

- Suggested braking resistance specification parameters

Braking resistance value and power in the chart are decided according to common inertia load and intermittent braking mode. While used in large inertia occasion or long time frequent brake occasion, please adjust resistance value and power according to the inverter specification and the rated parameter of braking unit. If any problem, please consult customer service department of Veichi electric company.

Three-phase 380V			
Motor power(kW)	Resistance value( $\Omega$ )	Resistance power(kW)	Braking moment (%)
0.75 kW	750 $\Omega$	150W	100%
1.5 kW	400 $\Omega$	300W	100%
2.2 kW	250 $\Omega$	400W	100%
4.0 kW	150 $\Omega$	500W	100%
5.5 Kw	100 $\Omega$	600W	100%
7.5 kW	75 $\Omega$	780W	100%
11 kW	50 $\Omega$	1,200W	100%
15 kW	40 $\Omega$	1,500W	100%
18.5 kW	32 $\Omega$	2,000W	100%
22 kW	32 $\Omega$	2,000W	100%
30 kW	24 $\Omega$	3,000W	100%

37 kW	20Ω	3,700W	100%
45 kW	16Ω	4,500W	100%
55 kW	13Ω	5,500W	100%
75 kW	9Ω	7,500W	100%
90 kW	6.8Ω	9,300W	100%
110 kW	6.2Ω	11,000W	100%
132 kW	4.7Ω	13,000W	100%
160 kW	3.9Ω	15,000W	100%
185 kW	3.3Ω	17,000W	100%
200 kW	3Ω	18,500W	100%
220 kW	2.7Ω	20,000W	100%
250 kW	2.4Ω	22,500W	100%
280 kW	2Ω	25,500W	100%
315 kW	1.8Ω	30,000W	100%
355 kW	1.5Ω	33,000W	100%
400 kW	1.2Ω	42,000W	100%
450 kW	1.2Ω	42,000W	100%
500 kW	1Ω	42,000W	100%
560 kW	1Ω	50,000W	100%
Single-phase 220V			
Motor power(kW)	Resistance value(Ω)	Resistance power(kW)	Braking moment (%)
0.4 kW	400Ω	100W	100%
0.75 kW	200Ω	120W	100%
1.5 kW	100Ω	300W	100%
2.2 kW	75Ω	300W	100%

**Chart 3-12: Suggested braking resistance specification parameters of AC80C series inverter**

- Build-in braking unit max braking performance

Braking unit of AC80C series product with low power can be selected according to the suggested braking resistance specification parameters in chart 3-11. In large inertia or long time frequent brake occasion, the moment maybe should be increased. The max braking power is showed in the following chart, the range of which can not be over in use. Otherwise the equipment maybe destroyed. If any problem, please consult Veichi electric company customer service department.

Three-phase380V			
Inverter model	Motor power	Max braking current	Min resistance
AC80C-T3-R75G	0.75 kW	3.5A	200Ω
AC80C-T3-1R5G	1.5 kW	3.5A	200Ω
AC80C-T3-2R2G	2.2 kW	7A	100Ω

AC80C-T3-004G	4 kW	10A	75Ω
AC80C-T3-5R5G	5.5 Kw	10A	75Ω
AC80C-T3-7R5G	7.5 kW	14A	50Ω
AC80C-T3-011G	11 kW	17A	40Ω
AC80C-T3-015G	15 kW	23A	30Ω
AC80C-T3-018G	18.5 kW	28A	25Ω
AC80C-T3-022G	22kw	28A	25Ω
Single-phase 220V			
Inverter model	Motor power	Max braking current	Min resistance
AC80C-S2-R40G	0.4 kW	3.8A	100Ω
AC80C-S2-R75G	0.75 kW	3.8A	100Ω
AC80C-S2-1R5G	1.5 kW	6.5A	60Ω
AC80C-S2-2R2G	2.2 kW	10.5A	40Ω

Chart 3-13:AC80C series inverter build-in braking unit max braking power

### Multi-function contact input connection

- NPN transistor connection mode

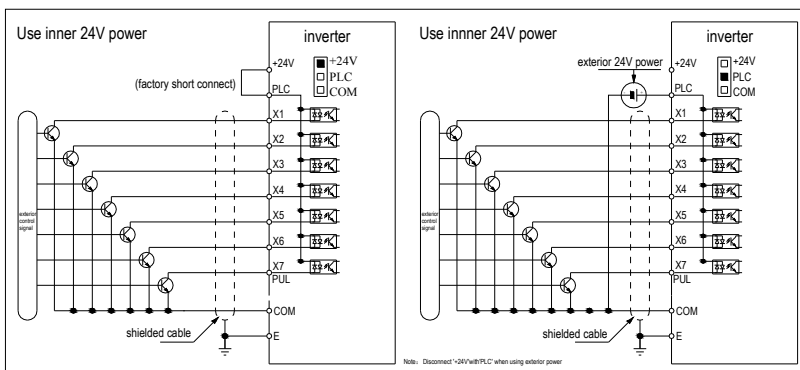

Chart 3-21: NPN transistor digital input signal connection mode

● PNP transistor connection mode

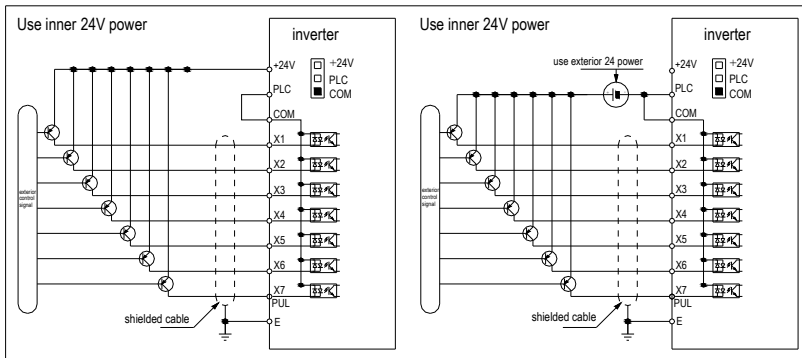

Chart 3-22: PNP transistor digital input signal connection mode

Digital output signal connection

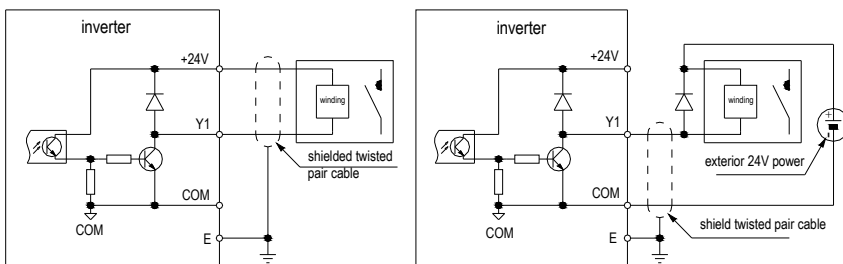
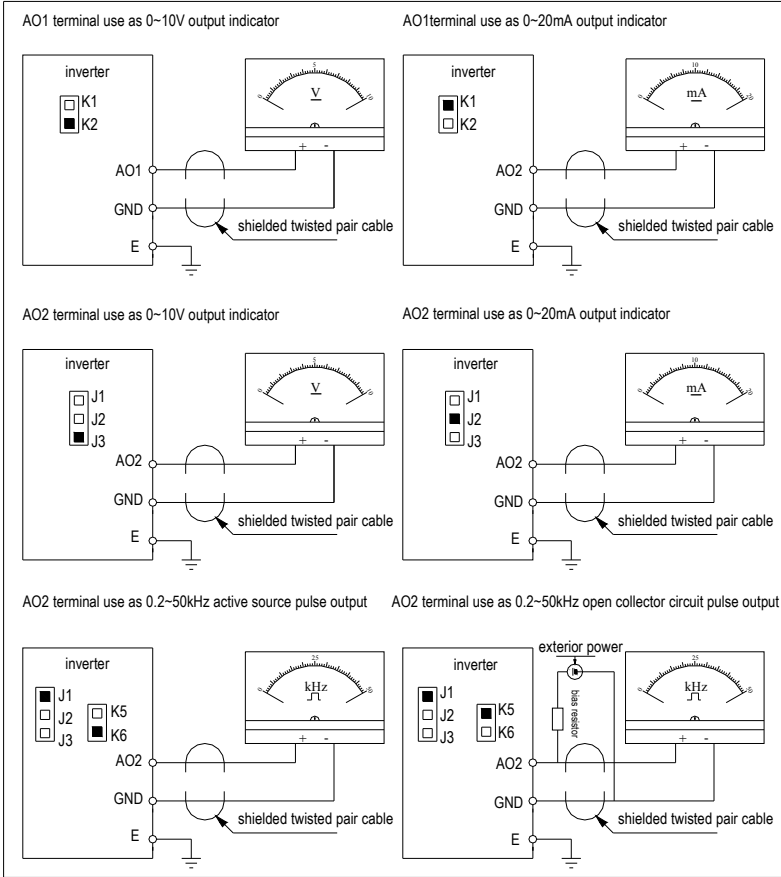

Chart 3-23:AC80C series inverter digital output signal connection mode

**Analog output signal connection**



**Chart 3-24: AC80C series inverter analog output signal connection mode**

**Connection of pulse input signal**

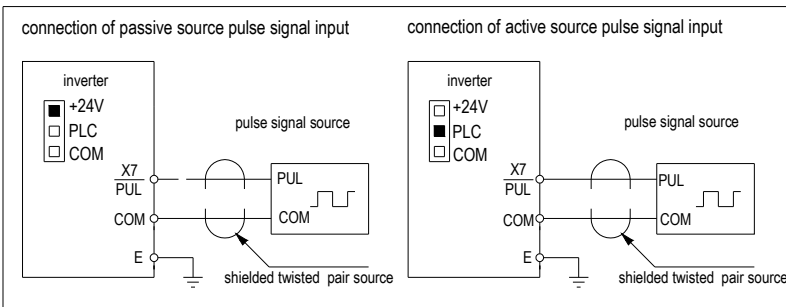
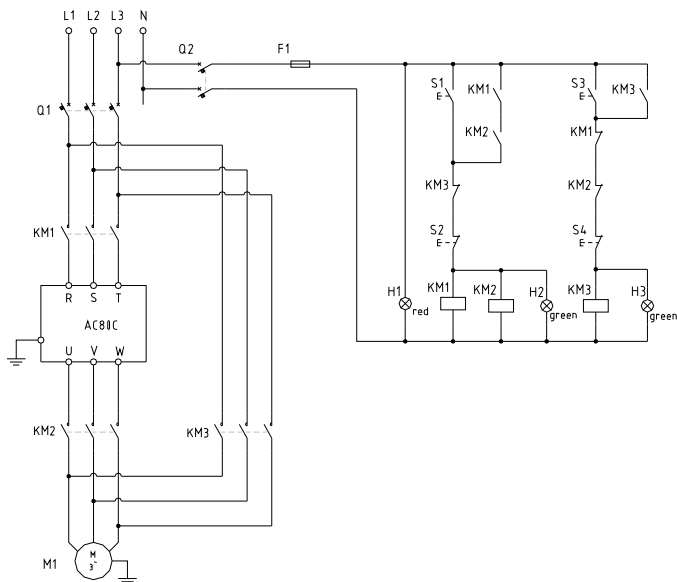

**Chart 3-25: Pulse input signal connection mode of AC80C series inverter**

## Standby control system

Frequency inverter is composed of semiconductor, passive electronic component and driving part. All of them have useful time, what means these parts may happen characteristic change or out of use while in normal working environment. And it will cause product fault. To avoid production stopping led by the fault, we suggest to prepare standby control system while use the inverter.



Chart3-26 is a standby control system for manual switch to power supply driving motor at inverter fault. Standby control systems such as power supply Y/Δ step-down start way driving motor, power supply self-coupling reduction voltage start mode driving motor, power supply soft start mode driving motor or standby inverter system can be chose to use according the actual requirement and environment.



**Chart 3-26: Standby control system of power supply directly driving mode**

## Chapter 4 Basic Operation and Trial Run

### 4.1 Safety Precautions

	<ul style="list-style-type: none"> <li>● No wiring while power supply is connected. Otherwise there is danger of electric shock.</li> </ul>
	<ul style="list-style-type: none"> <li>● No operation while the cover is open. Otherwise, there is danger of electric shock.</li> <li>● Please ensure reliable earth. Otherwise, there is danger of electric shock and fire.</li> <li>● Before wiring please cut power supply of all related equipments and ensure main DC voltage in safe range. And please do operation after 5 mins.</li> <li>● Only professional trained person is allowed to operate this product.</li> <li>● Please do not dismantle the inverter cover while it is electrified. Otherwise, there is danger of electric shock.</li> <li>● Please do not touch the printed circuit board of the inverter while it is electrified. Otherwise, there is danger of electric shock.</li> <li>● Please ensure reliable mains cable connection. If the mains cable is loose, there is danger of fire caused by joint overheating.</li> <li>● Before electrifying, please check the power voltage again. Wrong power voltage can cause fault or damage the inverter, even cause fire.</li> <li>● Please do not install inverter on flammable material or attach flammable material to the inverter. Before electrifying, please clear the surroundings.</li> </ul>
	<ul style="list-style-type: none"> <li>● While operation, please follow the ESD regulations. Otherwise, the inverter may be damaged.</li> <li>● Please don't cut the power directly while the inverter drives the motor running. The power can't be cut until the motor totally stops. Otherwise, the inverter may be damaged.</li> <li>● Please don't cut or connect motor while the inverter drives the motor running. The motor can't be cut or connect until the inverter output is 0. Otherwise, the inverter may be damaged.</li> <li>● Control cable should be twisted-pair shielded cable. The barrier should be connected to the inverter earth terminal reliably to prevent the inverter from abnormal working.</li> <li>● Unprofessional person can not operate, install, wiring, debug and maintain.</li> <li>● Change, dismantle or maintain without permission may cause inverter damage. This case is not in our quality assurance range.</li> </ul>











## 4.2 Keyboard layout and functions specification

### ● Keyboard appearance



### ● Key function

Key	Name	Function
	Menu key	Enter menu while standby or running. Press this key to return while modify parameter. While standby or running, press for 1 sec to enter condition monitoring interface.
	Confirm/modify key	Press to modify parameter while in menu interface. Press again to confirm after modifying. While standby or running, press to change LED monitoring items at stop.
	Up/down key	Select parameter group in menu interface. Modify parameter while in modify interface. Modify given frequency, PID, given torque or magnetic powder clutch given torque while at standby or condition monitoring state (While given frequency, PID, given torque or magnetic powder clutch given torque are set by keyboard and <b>[F4.04]</b> )
	Shift key	Select digit of function no modified by up/down key; Select parameter digits modified by up/down key. Change LED monitoring items while standby or running.
	Forward run key	While run/stop is controlled by keyboard, press this key, the inverter forward rotate and the indicator is always on. While reverse, the indicator sparks.
	Jog/reverse key	This key function can be defined by parameter <b>[F4.02]</b> . Press it, machine reverses and indicator is off if this key is defined as REVERSE. Machine will jog and indicator is on if this key is defined as JOG.
	Stop/reset key	Machine stops if press it while run/stop is controlled by keyboard. Its efficiency range is defined via function no <b>[F4.03]</b> . Inverter resets if press it in fault state (no reset if fault is not solved).
	Keyboard potentiometer	Can be used as input channel for given frequency, upper frequency limit, given torque, given PID or PID feedback setting.

● Indicator light meanings

Name	State	Meaning	
Unit indicator light	Hz	Spark	Digital display given requery.
	Hz	On	Digital display output frequency.
	A	On	Digital display actual output current.
	V	On	Digital display input voltage.
	V	Spark	Digital display output voltage.
	S	On	Time unit is second.
	S	Spark	Time unit is ms, min, or h.
	RPM	On	Digital display motor speed.
	%	Spark	Digital display given PID.
	%	On	Digital display PID feedback.
State indicator light	FWD	On	Inverter is forward rotating.
	FWD	Spark	Inverter is reverse rotating.
	FWD	Off	Inverter stops.
Function indicator light	REV/JOG	On	Jog.
	REV/JOG	Off	Reverse.

















Chart 4-1: Indicator light meanings

● Number and character table

Number, character	LED display	Number, character	LED display	Number, character	LED display
0		C		O	
1		D		P	
2		E		Q	
3		F		R	
4		G		S	
5		H		T	
6		I		U	
7		J		V	
8		K		W	
9		L		X	No display
A		M		Y	
B		N		Z	No display

Chart 4-2: Number and character table

### ● LCD keyboard function

Icon	Meaning
	Inverter at stop state
	Stand for forward running state
	Stand for reversal running state
	Stand for JOG running state
	Auxiliary sign Of reversal running state
	Remind to press "  " button
	Remind to press "  " button
	Tip of allowing shift up
	Tip of allowing shift down
	Icon shining means fault state
	Tip of content what arrow leads to
	Terminal off
	Terminal on
	Two kinds output of relay: one is open, the other is close at the same time

### ● Basic LED operation

It displays frequency 50.00Hz when stop. Here F0.09=100.00 setting will be taken as an example to explain the basic LED operation.

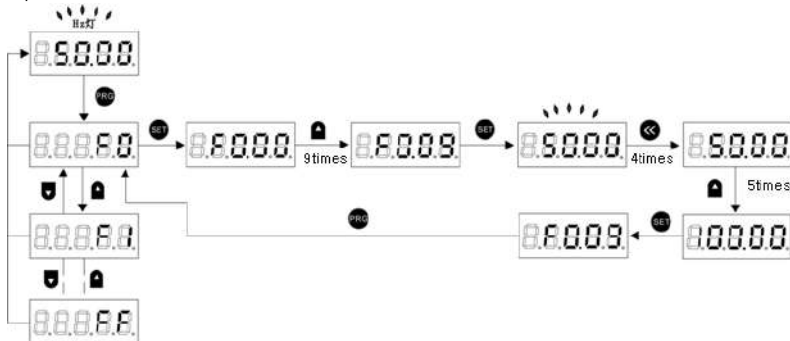

Chart 4-1: Basic LED operation

### 4.3 Basic operation

● **Parameter initialization**

After setting F0.19=1, parameter initialization is finished. Operation details as follows:

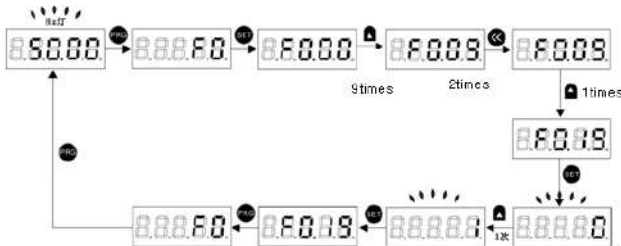

Chart 4-2: Parameter initialization

● **Core control mode selections**

Five core control mode selections:

- 0: V/F without PG
- 1: VC without PG
- 2: High-performance VC without PG
- 3: V/F with PG
- 4: VC with OG
- 5: High-performance VC with PG

Here we set F0.00=0 (V/F without PG control) as an example to introduce it

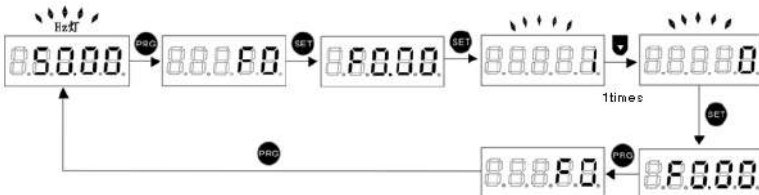

Chart 4-3: Core control mode selections

● **Run command instructions**

Four run command channels: 0: keyboard control, 1: terminal control, 2:RS485 communication control, 3: optional card. It can be set by F0.02.

Here we set F0.02=1(terminal control) as an example:

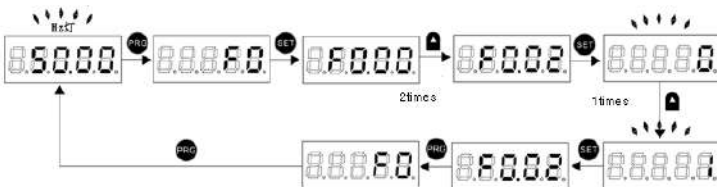

Chart 4-4: Run command instructions

It introduces terminal control two-wire 1, which is one kind of terminal control mode. For the other control modes, please refer the chapter 9.

● **Frequency command instructions**

There are many kinds of frequency command instruction selections. Please refer to chapter 9 for details. Here we set F0.03=1(keyboard potentiometer give frequency) as an example:

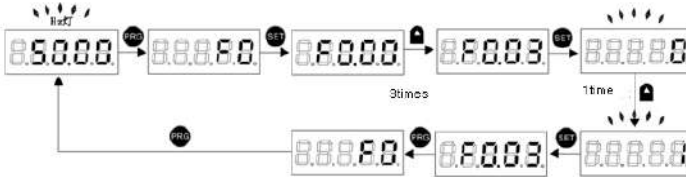

Chart 4-5: Frequency command instructions

● **Start-up mode selections**

Three start-up modes: 0: direct start-up, 1: braking firstly, then start by start-up frequency, 2: speed track and start-up. Here we set F1.00=2(speed track and start-up) as an example:

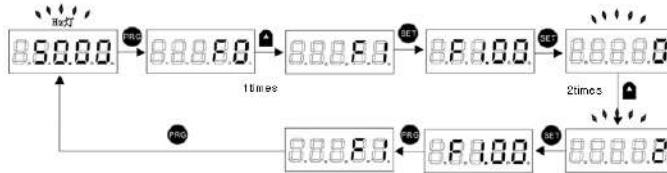

Chart 4-6: Start-up mode selections

● **Stop mode selections**

Two stop modes: 0: deceleration stop, 1: free stop, Here we set F1.07=1(free stop) as an example:

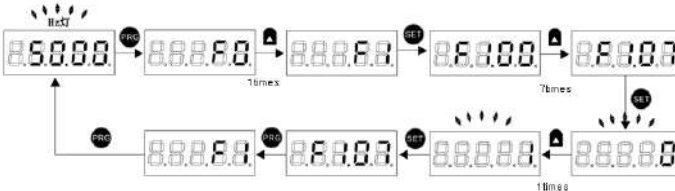

Chart 4-7: Stop mode selections

● **Acceleration/deceleration time selections**

There are 4 groups of acc/dec time. If no note, it is acc/dec time 1. Take setting F0.14=8.0 (acc/dec time 1) as an example:

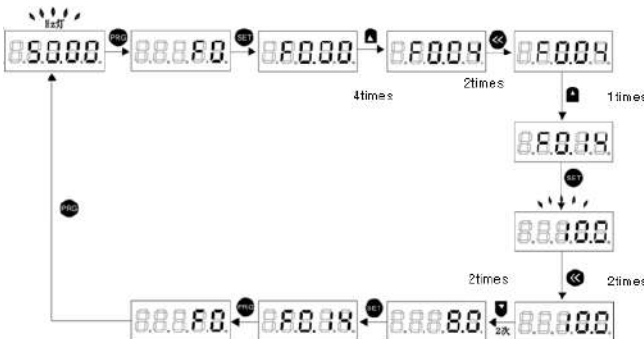

Chart 4-8: Acceleration/deceleration time selections

### ● Motor parameter setting

Set [F5.02] (motor rated power), [F5.03] (motor rated frequency), [F5.04] (motor rated speed), [F5.05] (motor rated voltage) according to the motor nameplate. Other parameter setting can be got by inverter self-study.

Please refer to the following operation mode chart:

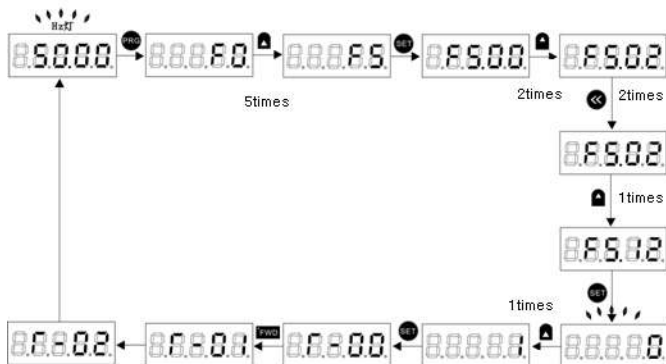

Chart 4-9: Motor parameter setting

### ● Parameter copy function selection

Set F4.05=1, send inverter parameter to keyboard and save:

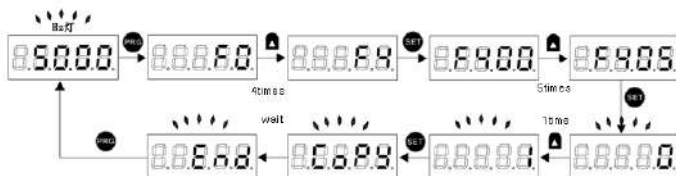

Chart 4-10: Send inverter parameter to keyboard and save

Set F4.05=2, send keyboard parameter to inverter:

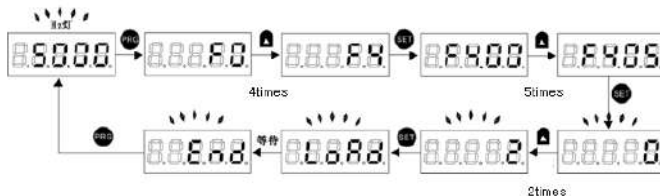

Chart 4-11: Send keyboard parameter to inverter and save

#### ● Run monitoring setting

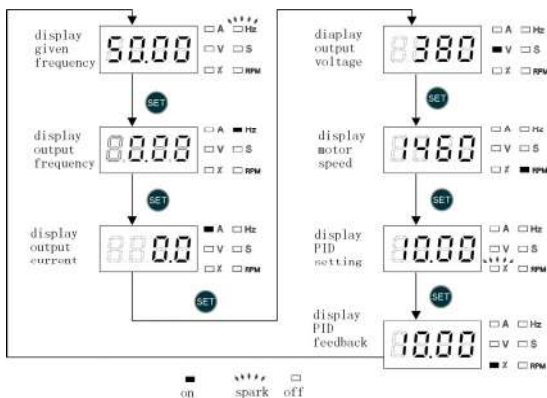

Chart 4-12: Run monitoring setting

## 4.4 LCD keyboard operation instructions

### ● Monitoring selections setting steps

Set monitoring parameter at stop state as an example to introduce, operations in chart 4-13. Set what first-line displays when inverter stops, please modify function parameter F4.11. Factory setting includes four-group parameters such as setting frequency, output frequency, output current and input voltage, you can press **SET** button to change it when inverter stops. You can also press **←** button to change what the second line displays.

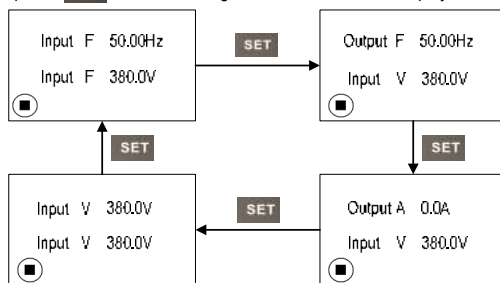

Chart 4-13: Operation of changing first-line monitoring parameter

### ● Operations of fault display

Introduce operations of rectifier bridge overheat fault display as an example, details in chart4-14. When keyboard displays fault, please press **SET** button to check fault reasons, and press **PRG** button to return back. If **▲** and **▼** display, you can press to check other fault reasons. You can press **STOP/RESET** button to reset fault in whole operation.

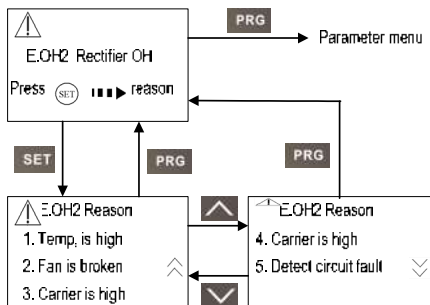

Chart4-14: Rectifier bridge fault display

### ● Operations of third-level menu

(1) Operations of changing lines: Introduce operations of initialization as an example, just set F0.19=1, details in chart 4-15

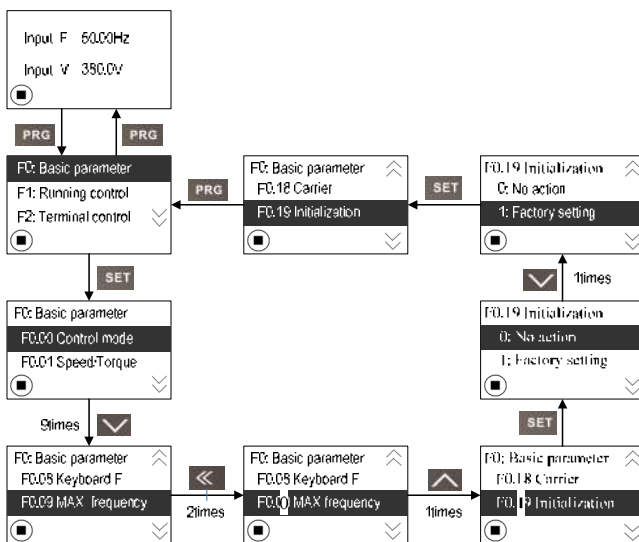

Chart4-15: Operations of changing lines



(2) Operations of data: Introduce setting main channel gain as an example, just set F0.04=2.000%, details in chart 4-16

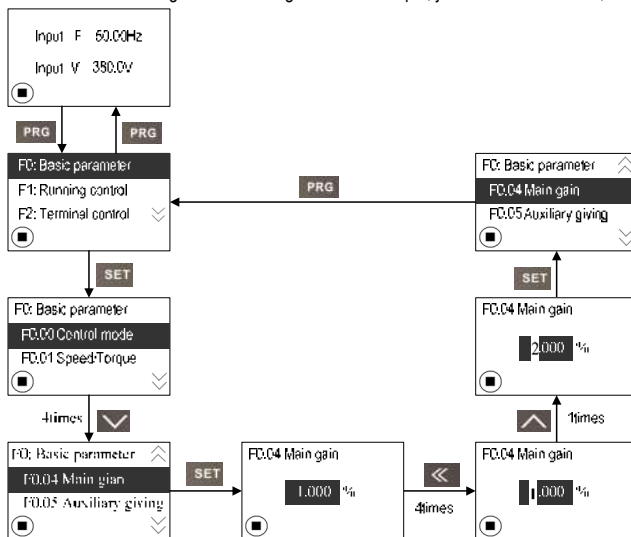

Chart4-16: Operations of modifying data

(3) Operations of groups: Introduce setting carrier frequency characteristic as an example, set '1. Related to output frequency' in group 2, details in chart 4-17.

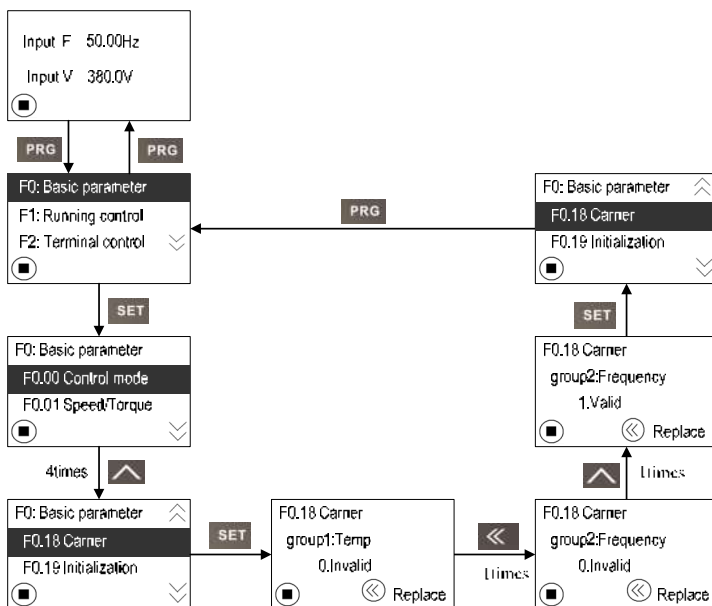

Chart 4-17: Operations of groups

- **Operations of parameters copy**

Operations of parameters copy in chart 4-18, and download in chart 4-19.

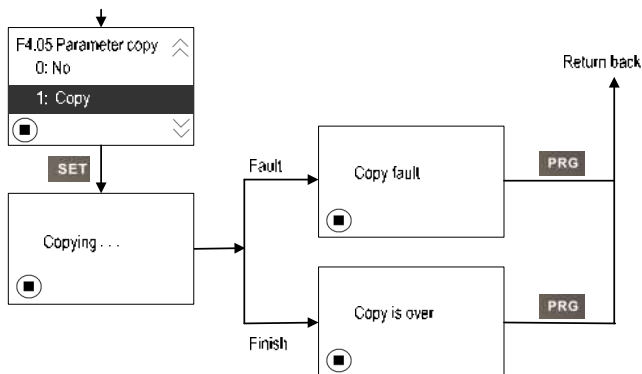

Chart4-18: Operations of parameter copy

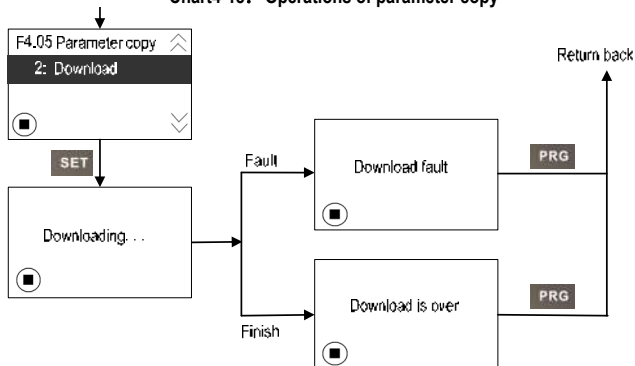
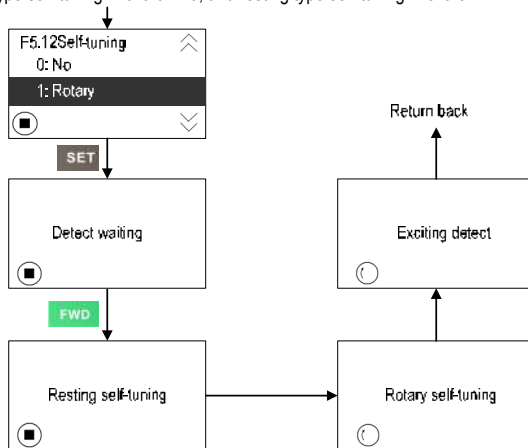

Chart4-19: Operations of parameter download

● **Operations of motor parameter self-tuning**

Operations of rotary type self-tuning in chart 4-20, and resting type self-tuning in chart 4-21.



**Chart4-20: Operations of rotary type self-tuning**

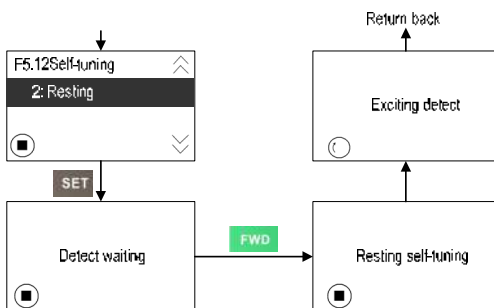

**Chart4-21: Operations of resting type self-tuning**

## 4. Trial run

### ● Trial run debugging guide

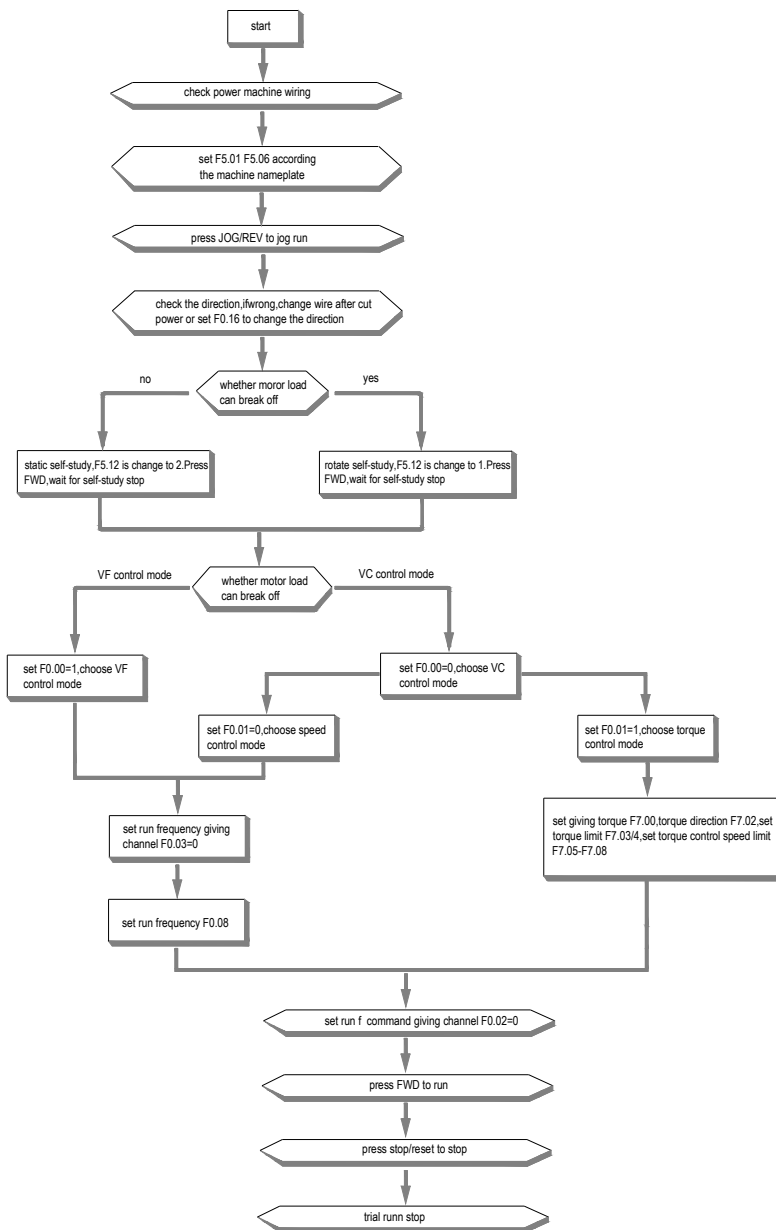

Chart 4-22: Trial run

## ● Parameter self-tuning selection

### Motor parameter self-tuning

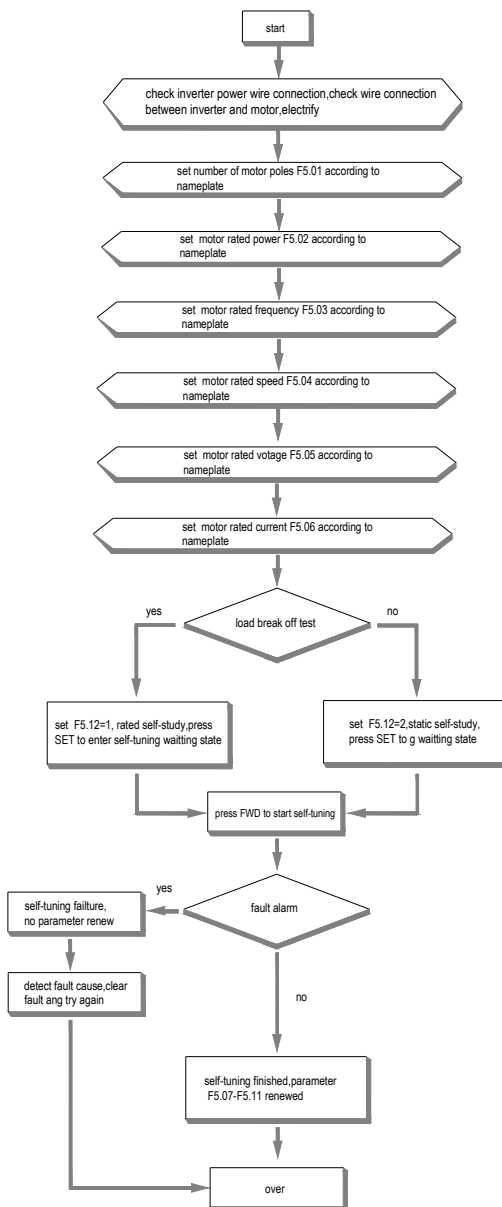

Chart 4-23: Parameter self-tuning selections

● Frequency giving flow

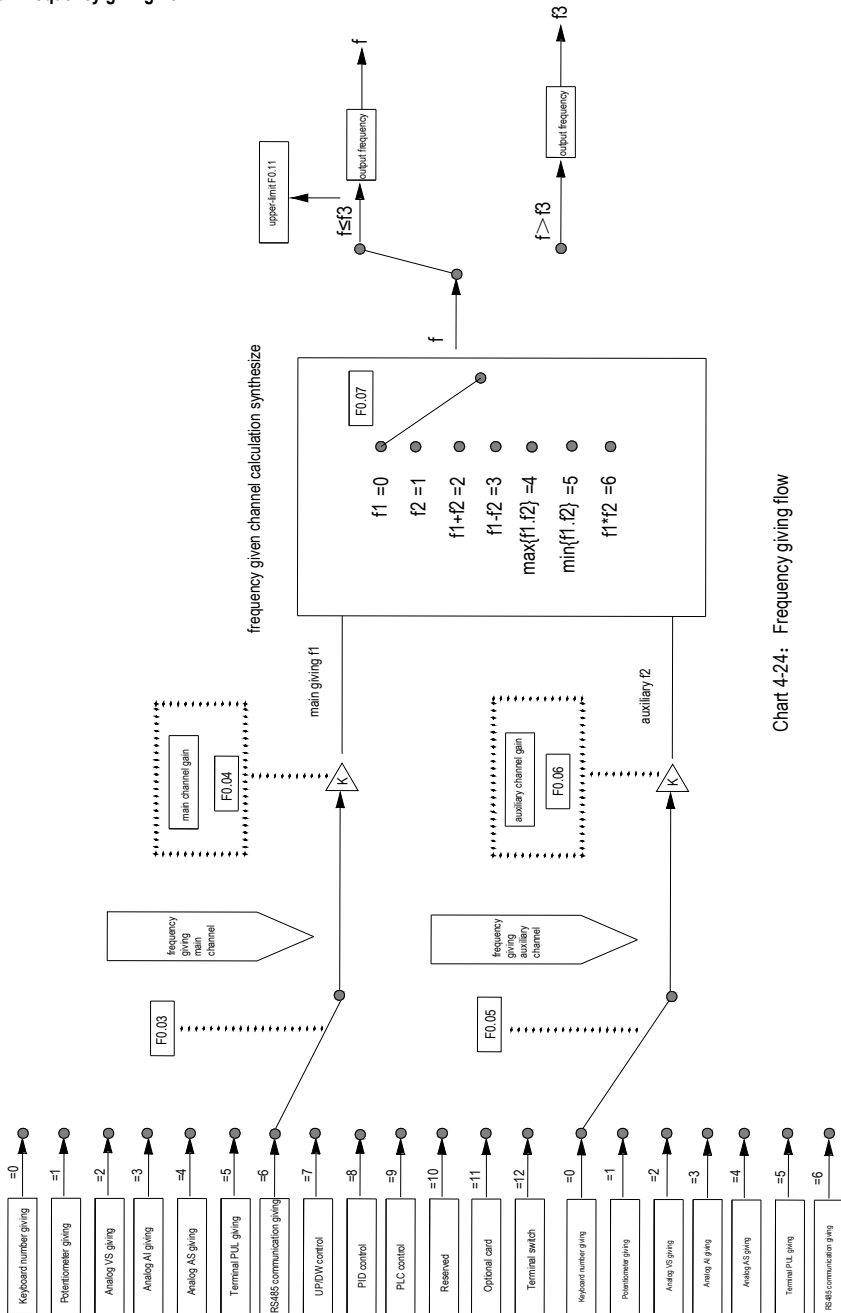

Chart 4-24: Frequency giving flow

● Start/stop control flow

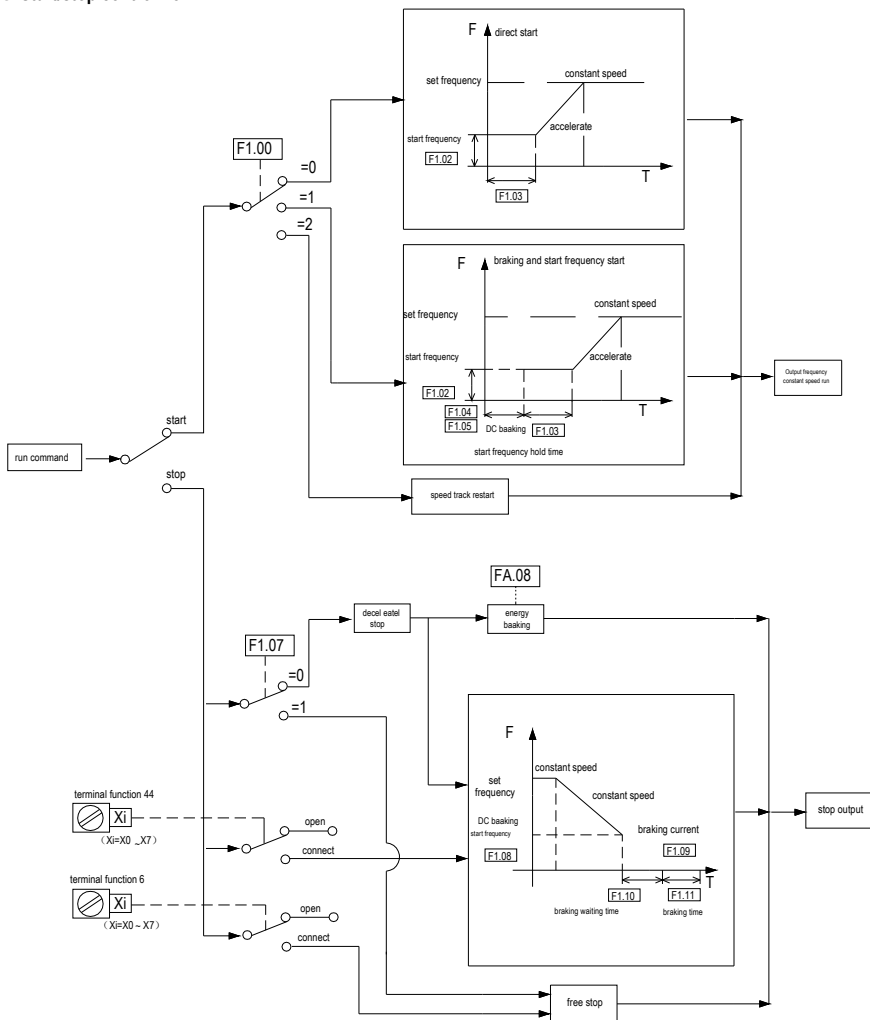

Chart 4-25: Start/stop control flow

## ● High-performance VC control without PG

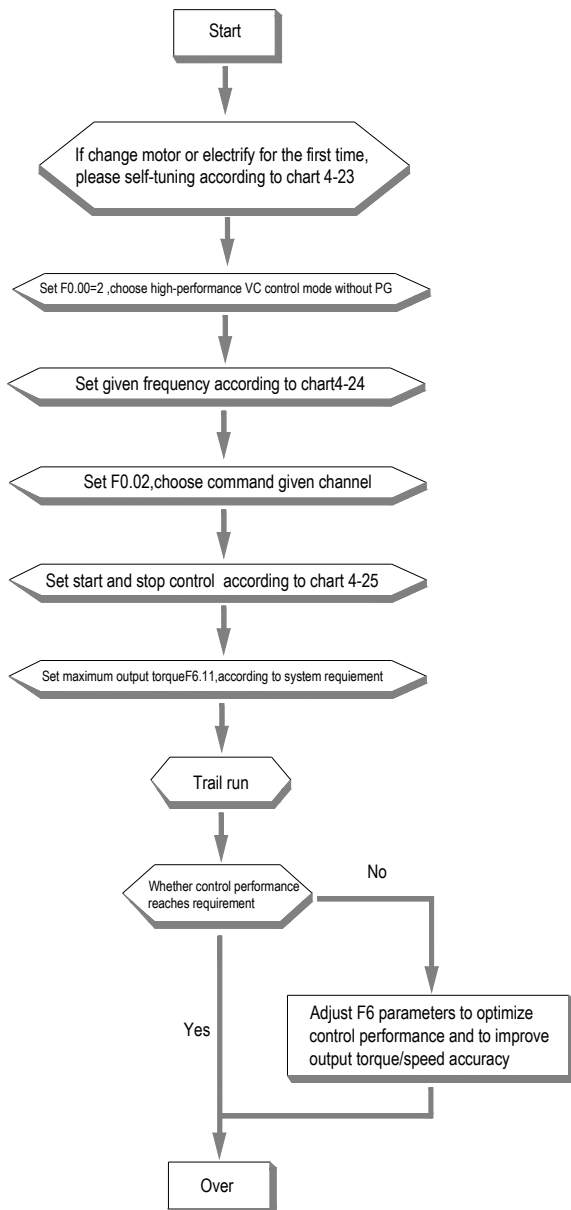

Chart 4-26: High-performance VC control without PG







## Chapter 5 Fault Diagnoses and Processing









This chapter explains the display content and process of the inverter fault, alarm and operation fault. It also simply explains the bad situation caused by inverter or motor fault and how to solve it. For the adjustment guide in trial run, please refer to this chapter too.

### 5.1 Fault types













Type	Inverter action while fault happens
Equipment fault	<p>While inverter detect fault, the state likes this:</p> <ul style="list-style-type: none"> <li>● Keyboard display character showing fault content.</li> <li>● Inverter stops output. Motor free slide stops.</li> <li>● While function F2.29 is set as 3(output fault), Y terminal output valid open-collector digital output.</li> <li>● While function F2.30/F2.31 is 3(fault output), TA1-TC1, TA2-TC2 terminals output open passive digital output.</li> <li>● While there is fault as OL, OC, SC, OV, UL2, if FA.22 is not 0, the inverter will restart automatically after FA.23 setting time.</li> </ul>
External fault	<p>In certain application occasions, external related equipments fault signals are considered in the inverter control system as usage of monitoring, protection or switch control. At this time, if one multi function terminal is defied as "external fault", the inverter stops output alarm signal.</p>

### 5.2 Fault information and details

Keyboard display	Fault code	Fault type	Possible causes	Treatment
	L.U.1	Too low while stop	<ul style="list-style-type: none"> <li>● Power supply is too low</li> <li>● Voltage detection circuit is abnormal</li> </ul>	<ul style="list-style-type: none"> <li>● Check input power, eliminate fault.</li> <li>● Seek support from factory.</li> </ul>
	E.LU2	Too low voltage in run	<ul style="list-style-type: none"> <li>● Power supply is too low</li> <li>● Power capacitance is too small, or there is big impact current in the power grid.</li> <li>● Inner DC main contactor is not closed.</li> </ul>	<ul style="list-style-type: none"> <li>● Check input input power, eliminate fault.</li> <li>● Improve power-supply system.</li> <li>● Seek support from factory.</li> </ul>
	E.oU1	Acc over-voltage	<ul style="list-style-type: none"> <li>● Power voltage fluctuation over limit.</li> <li>● Start running motor.</li> </ul>	<ul style="list-style-type: none"> <li>● Detect power voltage and eliminate fault.</li> <li>● Restart motor until it totally stop.Set F1.00 as 1or 2.</li> </ul>
	E.oU2	Dec over-voltage	<ul style="list-style-type: none"> <li>● Deceleration time is too short.</li> <li>● Load potential energy or inertia is too large.</li> <li>● Power voltage fluctuation over limit.</li> </ul>	<ul style="list-style-type: none"> <li>● Prolong deceleration time properly.</li> <li>● Reduce load inertia or improve inverter capacitance or add braking unit.</li> <li>● Detect input power and clear fault.</li> </ul>

	E.oU3	Constant speedover-voltage	<ul style="list-style-type: none"> <li>● Power voltage fluctuation over limit.</li> </ul>	<ul style="list-style-type: none"> <li>● Detect input power voltage and eliminate fault.</li> <li>● Install input reactor.</li> </ul>
	E.oU4	Over-voltage while stop	<ul style="list-style-type: none"> <li>● Power voltage fluctuation over limit.</li> </ul>	<ul style="list-style-type: none"> <li>● Check input power, eliminate fault.</li> <li>● Seek support from factory.</li> </ul>
	E.oC1	Acc over-current	<ul style="list-style-type: none"> <li>● Acceleration time is too short.</li> <li>● Start running motor.</li> <li>● V/F curve setting is not suitable.Or torque boost too high.</li> <li>● Inverter capacitance is too small.</li> </ul>	<ul style="list-style-type: none"> <li>● Prolong acc time.</li> <li>● Restart motor until it totally stop.Set F1.00 as 1or 2.</li> <li>● Reset V/F curve or torque boost value.</li> <li>● Select inverter with right capacitance.</li> </ul>
	E.oC2	Dec over-current	<ul style="list-style-type: none"> <li>● Deceleration time is too short.</li> <li>● Load potential energy or inertia is too large.</li> <li>● Power voltage fluctuation over limit.</li> </ul>	<ul style="list-style-type: none"> <li>● Prolong deceleration time.</li> <li>● Connect external braking resistance or braking unit.</li> <li>● Select inverter with right capacitance.</li> </ul>
	E.oC3	Constant speedover-current	<ul style="list-style-type: none"> <li>● Sudden load change.</li> <li>● Power grid voltage is too low.</li> </ul>	<ul style="list-style-type: none"> <li>● Check load change and eliminate it.</li> <li>● Check input power, eliminate fault.</li> </ul>
	E.oL1	Motor over-load	<ul style="list-style-type: none"> <li>● V/F curve setting is not suitable.Or torque boost too high.</li> <li>● Power grid voltage is too low.</li> <li>● Unright overload protection setting.</li> <li>● Locked-rotor run or too heavy load.</li> <li>● Universal motor long time low speed run.</li> </ul>	<ul style="list-style-type: none"> <li>● Reset V/F curve or torque boost value.</li> <li>● Check input power, eliminate fault.</li> <li>● Unreasonable F5.06 setting.</li> <li>● Adjust load or select inverter with right capacitance.</li> <li>● If need long low-speed operation, please choose special motor for inverter.</li> </ul>
	E.oL2	Inverter over-load	<ul style="list-style-type: none"> <li>● Load is too heavy.</li> <li>● Acceleration time is too short.</li> <li>● Start running motor.</li> <li>● V/F curve setting is not suitable.Or torque boost too high.</li> </ul>	<ul style="list-style-type: none"> <li>● Select inverter with right capacitance.</li> <li>● Prolong acceleration time</li> <li>● Restart motor until it totally stop. Set F1.00 as 1or2.</li> <li>● Reset V/F curve or torque boost value.</li> </ul>
	E. SC	System abnormality	<ul style="list-style-type: none"> <li>● Acceleration time is too short.</li> <li>● Short circuit between</li> </ul>	<ul style="list-style-type: none"> <li>● Prolong acceleration time properly.</li> <li>● Check periphery equipments</li> </ul>

			<p>inverter output phases or earth.</p> <ul style="list-style-type: none"> <li>● Module is damaged.</li> <li>● Electromagnetic disturb.</li> </ul>	<p>and restart after fault eliminating.</p> <ul style="list-style-type: none"> <li>● Seek support from factory.</li> <li>● Check system wiring, earth, shield and deal as required.</li> </ul>
EoH1	E.oH1	Inverter over-heat	<ul style="list-style-type: none"> <li>● Temperature is too high.</li> <li>● Air channel is blocked.</li> <li>● Fan connection parts is loose.</li> <li>● Fan is damaged.</li> <li>● Temperature detection circuit fault</li> </ul>	<ul style="list-style-type: none"> <li>● Make the environment meet the requirement.</li> <li>● Clear the air channel.</li> <li>● Check and reconnect the wire</li> <li>● Change the same new fan.</li> <li>● Seek support from factory.</li> </ul>
EoH2	E.oH2	Rectifier over-heat	<ul style="list-style-type: none"> <li>● Temperature is too high.</li> <li>● Air channel is blocked.</li> <li>● Fan connection parts is loose.</li> <li>● Fan is damaged.</li> <li>● Temperature detection circuit fault</li> </ul>	<ul style="list-style-type: none"> <li>● Make the environment meeting the requirement.</li> <li>● Clear the air channel.</li> <li>● Check and reconnect the wire.</li> <li>● Change the same new fan.</li> <li>● Seek support from factory.</li> </ul>
EFb1	E.Fb1	PID feedback over upper limit	<ul style="list-style-type: none"> <li>● PID feedback breaks.</li> <li>● PID feedback channels parameter is set wrongly.</li> <li>● Analog feedback channel is abnormal.</li> </ul>	<ul style="list-style-type: none"> <li>● Check PID feedback wire.</li> <li>● Check the PID feedback channel parameter setting.</li> <li>● Seek support from factory.</li> </ul>
EFb2	E.Fb2	PID feedback over lower limit	<ul style="list-style-type: none"> <li>● PID feedback breaks.</li> <li>● PID feedback channels parameter is set wrongly.</li> <li>● Analog feedback channel is abnormal.</li> </ul>	<ul style="list-style-type: none"> <li>● Check PID feedback signal wire.</li> <li>● Check the PID feedback channel parameter setting.</li> <li>● Seek support from factory.</li> </ul>
ETE1	E.TE1	Motor static detection fault	<ul style="list-style-type: none"> <li>● Detection overtime</li> <li>● Start static detection while motor is running.</li> <li>● Capacitance difference is too big between motor and inverter.</li> <li>● Motor parameter setting mistake.</li> </ul>	<ul style="list-style-type: none"> <li>● Check motor connection wire.</li> <li>● Detect after motor stopping totally.</li> <li>● Change inverter model.</li> <li>● Reset parameter according to nameplate.</li> </ul>
ETE2	E.TE2	Motor rotation detection fault	<ul style="list-style-type: none"> <li>● Detect while motor is running.</li> <li>● Detect with load.</li> <li>● Detection overtime</li> <li>● Capacitance difference is too big between motor and inverter.</li> <li>● Motor parameter setting mistake.</li> </ul>	<ul style="list-style-type: none"> <li>● Detect after motor stop totally.</li> <li>● Re-detect without load.</li> <li>● Check motor connection wire.</li> <li>● Change inverter model.</li> <li>● Reset parameter according to nameplate.</li> </ul>

	E.EEP	Memory fault	<ul style="list-style-type: none"> <li>● Electromagnetic disturb in memory period.</li> <li>● EEPROM damage.</li> </ul>	<ul style="list-style-type: none"> <li>● resume load and save.</li> <li>● Seek support from factory.</li> </ul>
	LIFE	Reserved	<ul style="list-style-type: none"> <li>●</li> </ul>	<ul style="list-style-type: none"> <li>● Seek support from factory.</li> </ul>
	E.ILF	Input side open phase	<ul style="list-style-type: none"> <li>● 3-phase input power open phase.</li> </ul>	<ul style="list-style-type: none"> <li>● Check 3-phase power supply and the phase.</li> <li>● Check 3-phase power supply wiring.</li> </ul>
	E.oLF	Ouput side open phase	<ul style="list-style-type: none"> <li>● 3-phase output power open phase</li> </ul>	<ul style="list-style-type: none"> <li>● Check 3-phase output voltage and current.</li> <li>● Check wiring.</li> </ul>
	E.Gnd	Output earth	<ul style="list-style-type: none"> <li>● Output earth terminal short circuit.</li> </ul>	<ul style="list-style-type: none"> <li>● Check wiring and insulation.</li> </ul>
	E.HAL	Current detection fault	<ul style="list-style-type: none"> <li>● Detect circuit fault.</li> <li>● Phase imbalance</li> </ul>	<ul style="list-style-type: none"> <li>● Seek for technic support.</li> <li>● Check motor and wiring.</li> </ul>
	E.EF	Inverter external fault	<ul style="list-style-type: none"> <li>● Peripheral equipment fault protection.</li> </ul>	<ul style="list-style-type: none"> <li>● Check peripheral equipment.</li> </ul>
	E.PAn	Keyboard connect fault	<ul style="list-style-type: none"> <li>● Keyboard wire fault.</li> <li>● Keyboard component damage.</li> </ul>	<ul style="list-style-type: none"> <li>● Check keyboard wire.</li> <li>● Seek support from factory.</li> </ul>
	E.CE	Rs485communication fault	<ul style="list-style-type: none"> <li>● Unsuitable baud rate setting.</li> <li>● Communication wire breaks.</li> <li>● Communication format does not match upper machine.</li> </ul>	<ul style="list-style-type: none"> <li>● Set suitable baud rate setting.</li> <li>● Check communication wire.</li> <li>● Set right communication format.</li> </ul>
	E.CPE	Parameter copy fault	<ul style="list-style-type: none"> <li>● Parameter copy communication is fault.</li> <li>● Copy keyboard is not match the inverter.</li> </ul>	<ul style="list-style-type: none"> <li>● Check wire.</li> <li>● Select the specified external keyboard model.</li> </ul>
	E.ECF	Extend card connection fault	<ul style="list-style-type: none"> <li>● Communication between extend card and frequency inverter overtime.</li> <li>● Extend card does not match frequency inverter.</li> </ul>	<ul style="list-style-type: none"> <li>● Check connector, and re-insert wire.</li> <li>● Choose the named card.</li> </ul>
	E.PG	PG card connection abnormal	<ul style="list-style-type: none"> <li>● PG card and inverter connection failure</li> </ul>	<ul style="list-style-type: none"> <li>● Check the connection</li> </ul>

<p style="color: red; font-weight: bold; font-size: 1.2em;">E.P. id</p>	<p>E.PID</p>	<p>PID feedback failure</p>	<ul style="list-style-type: none"> <li>● PID feedback upper limit of disconnection alarm is improper</li> <li>● PID feedback lower limit of disconnection alarm is improper</li> <li>● PID feedback wiring unreliable</li> <li>● Sensor with feedback failure</li> <li>● Feedback input loop failure</li> </ul>	<ul style="list-style-type: none"> <li>● Confirm the sensor state,if broken, change it.</li> <li>● Repair the wiring.</li> <li>● Confirm the setting value of [Fb.16] and [Fb.17].</li> </ul>
---	--------------	-----------------------------	---	---

Chart 5-1: Fault information and details

### 5.3 Fault diagnoses process

#### System fault diagnoses process

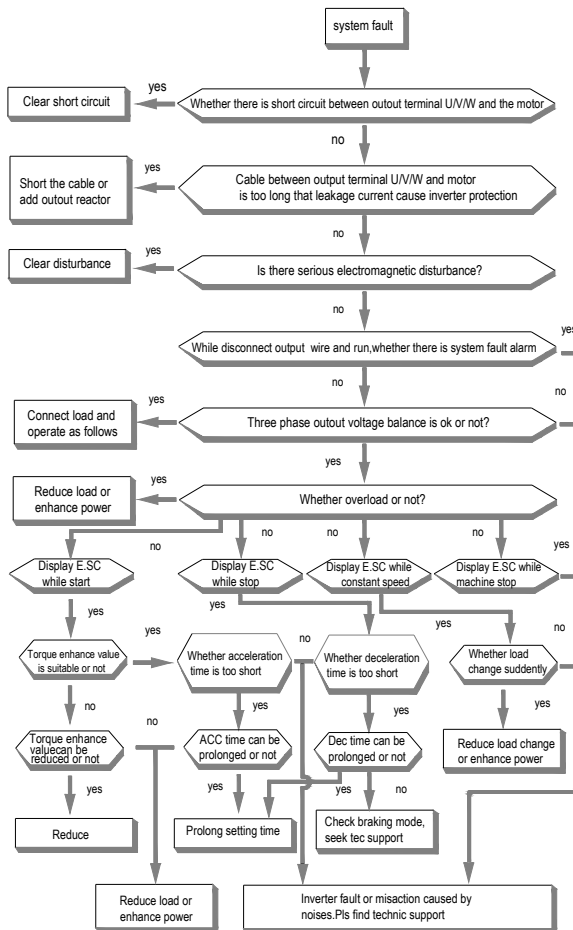

### Over current diagnoses process

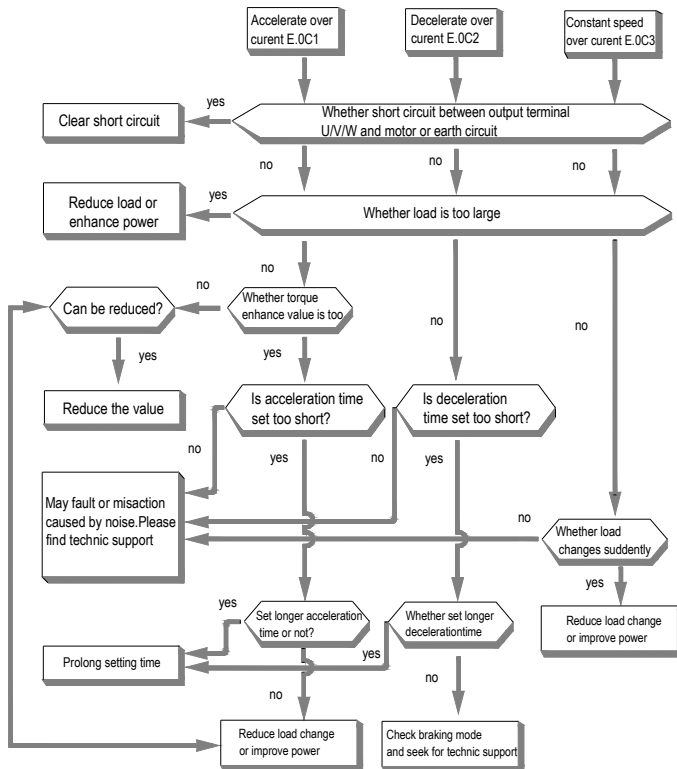

Over voltage diagnoses process

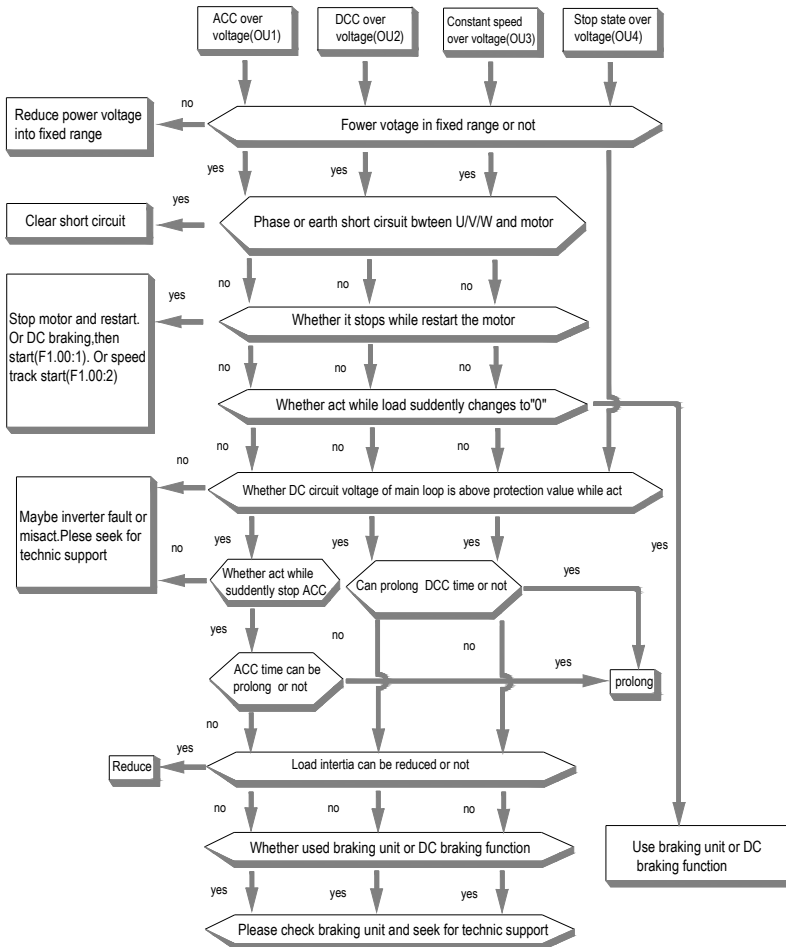

## Supply voltage is too low

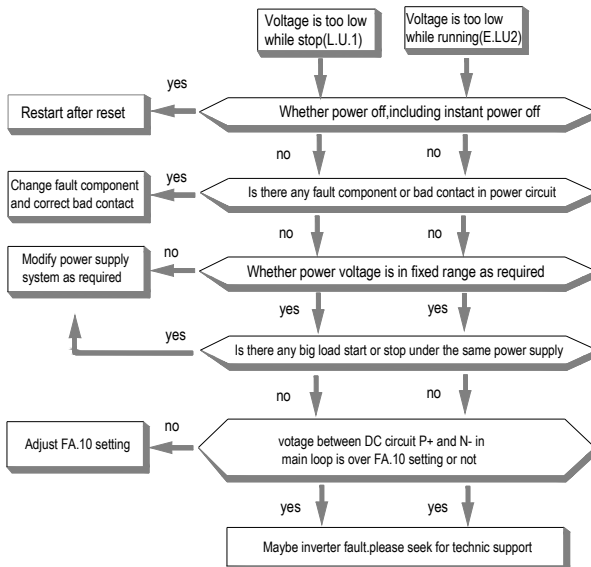

## Inner inverter over heat

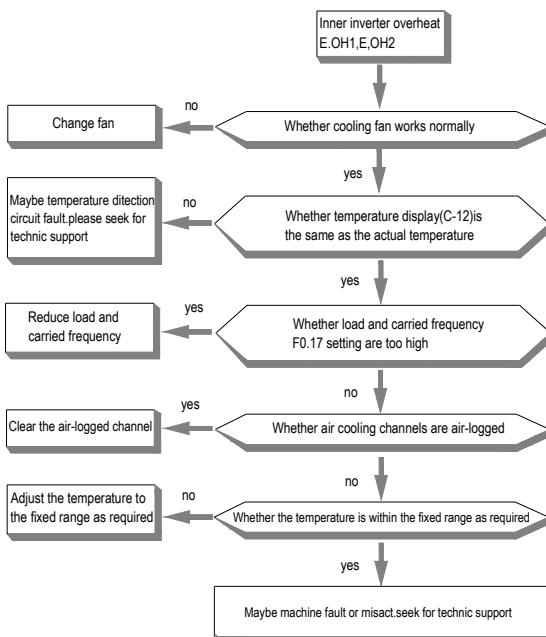



### Over load

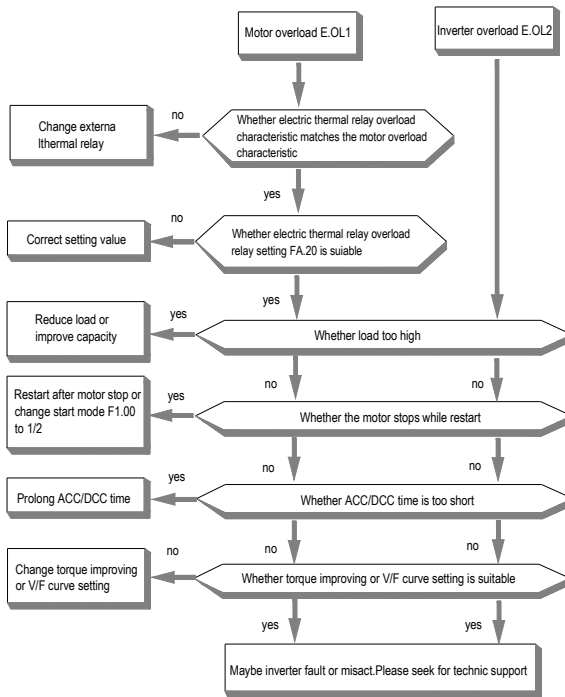

### No display

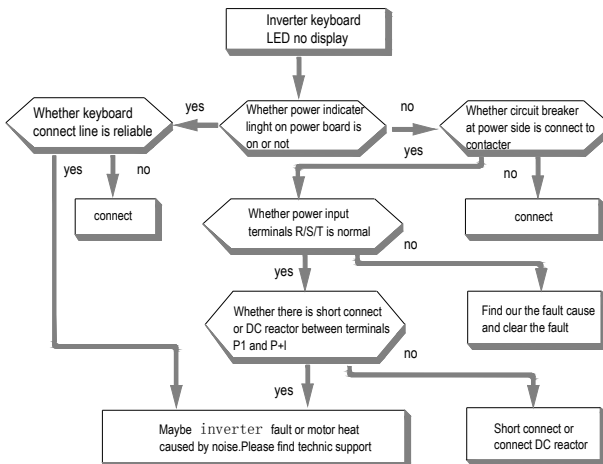

### Motor heat

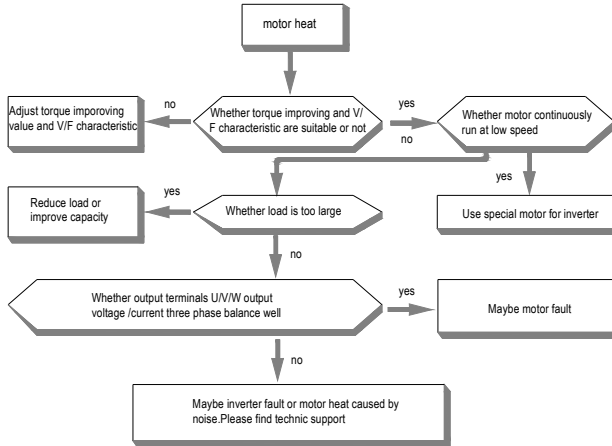

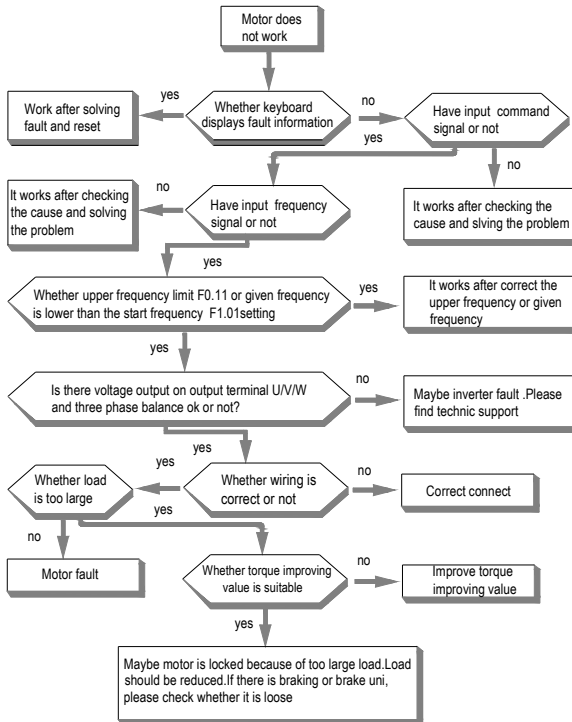

### Motor does not rotate



## Chapter 6 Periodic Overhaul and Maintenance

### 6.1 Safety Precautions

This chapter explains the safety rules in overhaul and maintenance.

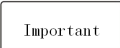
	<ul style="list-style-type: none"> <li>● No operation under power connected state. Otherwise, there is danger of electric shock even death.</li> <li>● Before operation, please cut all related equipments power, ensure that the main circuit DC current has dropped to safe range. And please operate after 5 mins.</li> </ul>
	<ul style="list-style-type: none"> <li>● No operation while cover/panel is dismantled. Otherwise there is danger of electric shock even death.</li> <li>● Do not dismantle the cover or PCB under power connected state. Otherwise there is danger of electric shock death.</li> <li>● Only professional person can maintain or change fittings. Otherwise, there is danger.</li> <li>● Do not wear loose clothes when install, debug, maintain. Related protective tools and safeguard should be adopted.</li> <li>● Tighten screw according to named torque. If main circuit wire connection is loose, there is danger of overheat fire.</li> <li>● Machine and motor earth must be reliable. Otherwise, there is danger of electric shock if touch the cover.</li> </ul>
	<ul style="list-style-type: none"> <li>● While operation, please follow the ESD regulations. Otherwise, the inverter maybe damaged.</li> <li>● Do not change the circuit or structure of the inverter. Otherwise, the inverter maybe damaged.</li> <li>● Please confirm the rotate direction while no-load. Wrong direction can bring body injury or huge wealth loss.</li> <li>● Do not use damaged machine. Otherwise, there is danger of accident.</li> </ul>

### 6.2 Overhaul

Frequency inverter is composed by semi-conductive components, passive electronic component and motive component. All of these components have useful life. Even under normal working environment, some of the components can not work after the life time. To avoid malfunction, daily checking, periodic overhaul, component changing and other maintenance should be carried out to prevent. We suggest one overhaul every 3-4 months after installation. The overhaul period should be shortened while under cases as below.

- High temperature, high altitude;
- Start and stop frequently;
- AC power supply or load fluctuant badly;
- With serious vibration or impact;
- With dust, metal dust, salt, vitriol, chlorine;
- Bad storage environment;

### ● Daily checking

To avoid machine damage and to prolong life time, please check the following items everyday.

Items	Checking content	Treatment
Power supply	Check if power supply meets the requirement and whether there is lack-phase.	Treat it as nameplate explains.
Surroundings	Check whether it meets the table3-1 requirement.	Make sure the problem and solve it.
Cooling system	Check whether the inverter or the motor heat or change color abnormally and cooling fan working state.	Check whether it overload. Tighten screw. Check whether cooling fan is dirty or stall rotate.
Motor	Check if there is abnormal vibration or noise.	Tighten machine and electric connection and lubricate the machine components.
Load	Check whether output current is over the rated value of the motor or the inverter and has lasted for a period.	Make sure whether it overload and whether the machine model is right.



No operation under power connected state. Otherwise, there is danger of electric shock death. Before operating, please cut all related equipments power, ensure that the main circuit DC current has dropped to safe range. And please operate after 5 mins.

### ● Periodic overhaul

Under normal state, one overhaul every 3 or 4 months is ok. Please confirm the actual overhaul period according to the machine use condition and work circumstance while using the machine.

#### Main circuit

Items	Checking content	Treatment
Whole	Check insulated resistance; Check circumstance.	Tighten and change bad component; Clear and improve circumstance.
Electric connection	<ul style="list-style-type: none"> <li>● Check whether the wire and connector color changes, whether there is disrepair, crack color change or aging in insulated layer.</li> <li>● Check whether the connect terminals are frayed, damaged or loose.</li> <li>● Earth checking.</li> </ul>	<ul style="list-style-type: none"> <li>● Change bad wire.</li> <li>● Fasten terminals and change bad terminals.</li> <li>● Measure earth resistance and fasten earth terminals.</li> </ul>
Mechanical connection	<ul style="list-style-type: none"> <li>● Check if there is abnormal vibration or noise or something is loose.</li> </ul>	<ul style="list-style-type: none"> <li>● Tighten, lubricate and change the bad components.</li> </ul>
semi-conductive component	<ul style="list-style-type: none"> <li>● Check whether there is dust or rubbish.</li> <li>● If there is obvious out change?</li> </ul>	<ul style="list-style-type: none"> <li>● Clean operation environment</li> <li>● Change damaged component</li> </ul>
Electrolytic capacitor	<ul style="list-style-type: none"> <li>● Whether there is liquid leak, color change or crack. Whether the safety valve outcrop, inflation, creak or liquid leak.</li> </ul>	<ul style="list-style-type: none"> <li>● Change damaged component</li> </ul>

Peripheral equipment	<ul style="list-style-type: none"> <li>● Peripheral equipment outlook and insulation checking.</li> </ul>	<ul style="list-style-type: none"> <li>● Clear and change damaged component.</li> </ul>
PCB	<ul style="list-style-type: none"> <li>● Peculiar smell color change, bad rust and connector checking.</li> </ul>	<ul style="list-style-type: none"> <li>● Fasten connector</li> <li>● Clear PCB</li> <li>● Change damaged PCB</li> </ul>
Cooling system	<ul style="list-style-type: none"> <li>● Check whether the fan is damaged or blocked up.</li> <li>● Whether rubbish and dust is stuck to the heatsink .</li> <li>● Is air inlet/outlet blocked? Or is there something sticking to the inlet/outlet.</li> </ul>	<ul style="list-style-type: none"> <li>● Clean operation environment</li> <li>● Change damaged component</li> </ul>
Keyboard	<ul style="list-style-type: none"> <li>● Whether it is damaged. Check whether display is complete.</li> </ul>	<ul style="list-style-type: none"> <li>● Change damaged component</li> </ul>
Motor	<ul style="list-style-type: none"> <li>● Check if there is abnormal vibration or noise.</li> </ul>	<ul style="list-style-type: none"> <li>● Tighten machine and electric connection and lubricate the machine components.</li> </ul>



No operation under power connected state. Otherwise, there is danger of electric shock death. Before operating, please cut all related equipments power, ensure that the main circuit DC current has dropped to safe range. And please operate after 5 mins.

## 6.3 Maintenance

All equipments and components have useful life. Right maintenance can prolong the lifetime. But it can not avoid damage. Please change the components before their lifetime over.

Component	Useful lifetime
Fan	2~3year
Electrolytic capacitor	4~5 year
PCB	8~10 year

### ● Fan



While changing fan, please use original fan. You can contact Veichi company or the dealer. There are inverter models with many fans in one machine. To prolong these machines' lifetime, you had better to change all fans while changing the cooling fan.

### ● Fan change method:

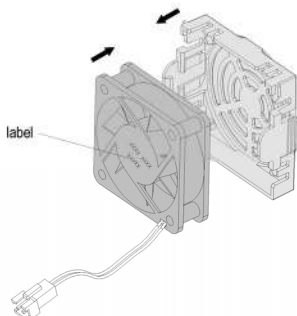

1. Install the fan vertically into the cover as shown in the picture (the label should face the outside).

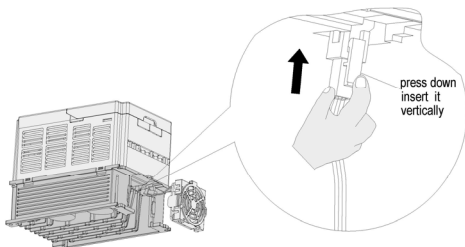

2. Press the elastic clip of the fan by finger toward the inner side and insert the leading terminal of the fan vertically by a little strength.

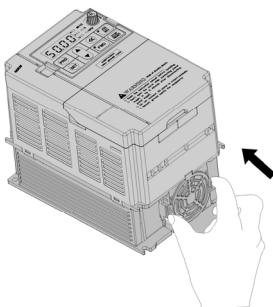

3. Insert the two elastic clips of the fan cover vertically into the fan installation slots.

● **Fan dismantlement:**

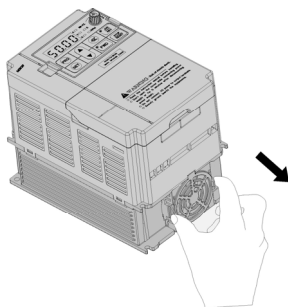

1. Pinch the two elastic clips of the fan and pull out. Then dismantle the fan cover.

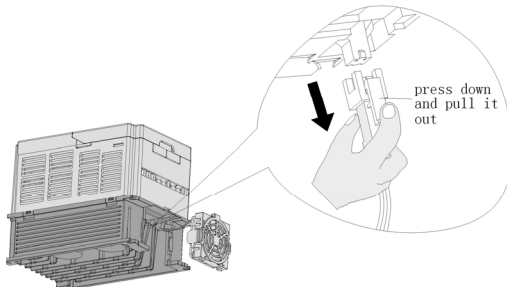

2. Press the elastic clip of the fan by finger toward the inner side and pull out the leading terminal of the fan vertically by a little strength.

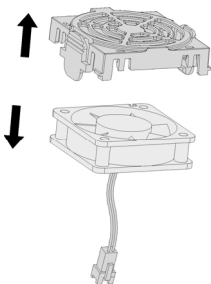

3. Poke the clips toward the outside and detach the fan from the cover by a little strength.



1. No operation under power connected state. Otherwise, there is danger of electric shock death. Before operating, please cut all related equipments power, ensure that the main circuit DC current has dropped to safe range. And please operate after 5 mins.
2. While the inverter is working, the heatsink temperature will be higher as the consumption. To prevent from scald, please do not touch the heatsink and do not change the fan until the temperature being safe.
3. To ensure the best performance of the inverter, please use the original fan.



#### ● Other components

The replacement of the other components has strict requirements on maintenance technic and product familiarity. And they can not be used without strict detection after replacement. So we suggest the user not to replace the other inner components. If they need to change indeed, please contact to the dealer or the sales department of Veichi electric company.

## Chapter 7 Peripheral Equipments and Options



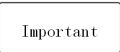

### 7.1 Safety Precautions

User must obey to the following safety rules and related requirements while using the peripheral equipments and selecting components.





	<ul style="list-style-type: none"> <li>● No operation under power connected state. Otherwise, there is danger of electric shock.</li> <li>● Before operation, please cut all related equipments power, ensure that the main circuit DC current has dropped to safe range. And please operate after 5 mins.</li> </ul>
	<ul style="list-style-type: none"> <li>● No operation while cover/panel is dismantled. Otherwise, there is danger of electric shock.</li> <li>● Do not dismantle the cover or PCB under power connected state. Otherwise, there is danger of electric shock.</li> <li>● Only professional person can install, debug or maintain the peripheral equipments and options. Otherwise, there is danger.</li> <li>● Do not wear loose clothes when install, debug, maintain. Rated protective tools and safeguard should be adopted.</li> <li>● Do not change wire, dismantle jumping wire, optional card, or change cooling fan while the inverter is running. Otherwise, there is danger of electric shock.</li> <li>● Tighten screw according to named torque. If main circuit wire connection is loose, there is danger of overheat fire.</li> <li>● Earth of the peripheral equipments and options must be reliable to prevent human body injury.</li> </ul>
	<ul style="list-style-type: none"> <li>● While operation, please follow the ESD regulations. Otherwise, the inverter maybe damaged.</li> <li>● Do not cut the power supply while the inverter is outputting voltage. Otherwise, the inverter maybedamaged.</li> </ul>

### 7.2 Peripheral equipments

Normal peripheral equipments are showed as follows. To order the peripheral equipments, please consult our dealer or sales department.

Peripheral equipment		Functions
	Breaker	Protect power system and prevent malfunction impact other equipments working when short-circuit happens. And over-load protection.
	Leakage current breaker	Earth protection prevent electric shock(suggest to use the type which can prevent high-frequency leakage current)
	Electromagnetic contactor	Separate power and inverter indeed and realize basic relay control.
	AC input reactor	Improve power side factor and isolate the noise disturbance to the frequency inverter from the power side.



	DC reactor	Restrain ultraharmonics and improve power factor.
	Input side noise filter	Reduce frequency inverter disturbance to the power and reduce the power grid disturbance.
	Braking resistor	Passive energy consume unit of electric braking.
	Consumption braking unit	Electric braking control unit, controlling the braking resistance consume the regenerated electric power of the motor efficiently.
	Output side noise filter	Reduce the output side wire electromagnetic disturbance.
	Standby system	Standby system for inverter malfunction.
	Heat relay	Protect the motor while over load.
	0-phase reactor	Reduce electromagnetic disturbance of the frequency inverter (suitable for input/output side).
	Main loop surge absorbable unit	Restrain surge voltage while main loop switch components act.
	Winding surge absorbable unit	Restrain surge voltage when the AC contactor acts.

### 7.3 The use of peripheral equipments

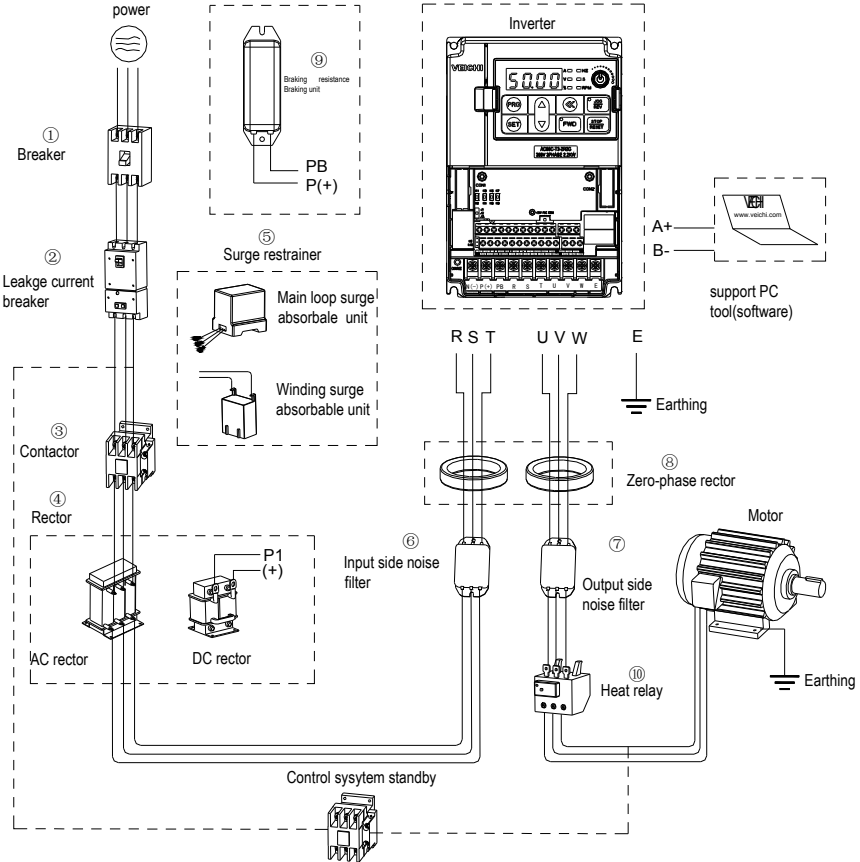

Chart 7-1: Peripheral equipments connection fig

**Note:**

**① Wiring breaker**

To ensure wiring safe, protect power system and prevent malfunction impact other equipments working when short-circuit happens, and protect while over-load, please do use wiring breaker between power supply and main loop power input terminals R,S,T.



While choosing the breaker, the capacitance should be about 1.5-2 times of the rated output current of the frequency inverter. Please compare the time characteristic of breaker and the characteristic of the inverter protection (150% of the rated output current, one minute). Make sure there will be no skip.



Before main loop wiring, make sure to cut the breaker and electromagnetic contactor. Otherwise, there is danger of electric shock.

**② Leakage current breaker**

The frequency inverter outputs peak voltage high-speed switch square wave, so there is high frequency leakage current. For earth protection to prevent electric shock and leakage current fire, please install leakage current breaker. Usually,

one frequency inverter will bring 100mA leakage current (while the power cable length is 1m). If the length prolongs 1m, there will be 5mA more leakage current. So please use leakage current breaker special for high frequency leakage at the power input side of the frequency inverter. The factors which impact leakage current are as follows:

Capacitance of inverter;

Carrier frequency;

Motor cable type and wire length;

EMI/RFI filter.

To protect human body and inverter, please choose leakage current breaker which can use AC/DC power and can reply high frequency leakage current. There should be one leakage current breaker with more than 200mA sensitive current for every frequency inverter. If the frequency inverter outputs different wave, the high frequency leakage current will be higher, what will make the breaker malfunction. At this case, please take following treatments:

Improve the sensitive current of the leakage current breaker;

Reduce the carrier frequency of the inverter.

### ③ Electromagnetic contactor

Electromagnetic contactor is a peripheral equipment what is set to separate power and inverter connection. While inverter protective function is acting or carrying out emergency stop operation, the main loop power can be cut by peripheral equipment. Please do not connect the electromagnetic switch or electromagnetic contactor to output circuit. Otherwise, the inverter maybe damaged. While the power recovers after instant stop, if it needs to prevent the inverter to auto-restart, please install electromagnetic contactor for control at the input side.

### ④ AC input reactor and DC reactor

To restrain current sharp change and high hypo harmonic current, it needs to use AC input reactor and DC reactor. It can also improve power factor at the input side. In the following cases, AC input reactor or DC reactor must be used (use both will bring better effect).

Need to restrain ultraharmonics current and improve power side factor;

Need to switch input phase capacitance;

When frequency inverter is connected to large capacitance power transformer (600kVA above);

Silicon-controlled converters such as DC motor driver are connected to the same power system.

The DC reactor, whose parameters are designed only for individual odd harmonic, is built inside AC80C series (90KW above). If user has higher requirement on other harmonic restraint, please connect the external DC reactor (The DC reactor is built inside AC80C series frequency inverter. At the same time, the external DC reactor connection terminal is fetched out. They are in series structure). Before connecting the external DC reactor, make sure to dismantle the short connector between the terminals P1 and (+).

### ⑤ Surge restrainer

Surge restrainer is divided to winding surge restrainer and main loop surge restrainer according to the use position. Pls choose the right one which is suitable for the occasion. The aim of surge restrainer installation is restraining the surge voltage brought by switch components such as inductive load which is surrounding the frequency inverter (electromagnetic contactor, electromagnetic relay, electromagnetic valve, electromagnetic winding, electromagnetic detent). Do not connect the surge restrainer to the output side of the frequency inverter. Otherwise, the frequency inverter will be damaged.

### ⑥ Input side noise filter

Rectifier bridge of the inverter is uncontrolled rectifier. And input current is discontinuous impulse current. So the harmonic current noise signal, what flows to power wire from the inverter inner, maybe bring bad impact on the surrounding machines (radio, phone, noncontact switch, sensor). This time, we suggest to instal input side noise filter to lighten the noise into the power wire. Besides, it can also reduce noise from the power wire into the frequency inverter.



Please use the special noise filter for the frequency inverter and the connection wire between the filter and the inverter should be as short as possible.

### ⑦ Output side noise filter

The frequency inverter outputs square wave with high-speed peak value voltage switch. So there is high-speed dv/dt coner on the output cables that will produce a large number of radio disturbance and inductive signal. By installation noise filter at the output side, the impact can be relieved. Please do not install the into phase capacitance and the noise filter to the output circuit. Otherwise, there is danger of damage to the frequency inverter.

### ⑧ 0-phase reactor

0-phase reactor is used for reducing the electromagnetic interference of the frequency inverter, which is suitable for the input side and output side. It equals to a three-phase common mode inductance. In actual use, according to the actual magnetic core size and cable specification, it is better to make sure 3-5 circles winding ratio to bring the best performance.

### ⑨ Braking reactor or braking unit

Renewable electricity consumption unit, please see the sixth part of the chapter three "electric installation".

### ⑩ Heat relay

Please install the heat relay at the output side of the frequency inverter. When the motor enters into overload state, it will cut the power source to protect the motor. While using one frequency inverter to drive one motor, it is unnecessary to install heat relay. The motor overload protection current [FA.20] of the frequency will work. While using one frequency inverter to drive multiple motors or the motor is drove directly by the power grid, please install heat relay between the inverter and the motor. While installing the heat relay, please design to cut the sequence control circuit of the MC at the main loop iuput side by the connection spot of the relay or design to input the heat relay action into the frequency inverter as the exterior malfunction. And please pay attention to the following tips to avoid heat relay malfunction and motor overheating at low speed.

Run at low speed

One frequency inverter run multiple motors

Motor cable is very long

Detect malfunction mistakenly for carrier frequency is too higher.

#### Low speed and heat relay

In normal case, the heat relay is suitable for the universal motor. While using the frequency inverter to run the universal motor (standard motor), the motor current is 5-10% higher, comparing with the commercial power supply. Besides, at low speed, even in the motor rated current range, the cooling capability of the fan drove by the motor axis will reduce, which will bring motor overheat. So please set the motor overheat protection current [FA.20] in the frequency inverter to be valid.

#### Motor cable is longer

While the motor cable is longer and the carrier frequency is higher, impacted by the leakage current, the heat relay maybe malfunction. To avoid it, please reduce the carrier frequency or set higher detection value of the heat relay. Before enhance the detection value, do confirm whether there is other cause for the motor overheat. Otherwise, there is danger.

## Chapter 8 Quality Guarantee

### 8.1 Guarantee time and range

#### Guarantee time

Users can enjoy the following "three guarantee" service from the day of buying products if meeting products quality problem:

- We guarantee for repair, return and replacement for one month after delivery;
- We guarantee for repair and replacement for two months after delivery;
- We guarantee for repair for eighteen months after delivery;
- The articles above do not apply to export.

#### Guarantee range

Installation and debugging: In principle, it should be carried by users. Our company provides technical support. But we can afford installation and debugging service with charge.

On-site diagnosis: In principle, it should be carried by users. Our company gives technical support. But we can afford on-site diagnosis service with charge. According to diagnosis, if it is our liability, it will be free.

Malfunction maintain: While meeting malfunction, if it is quality problem and within guarantee time, we will repair free of charge. The malfunctions, caused by the reasons mentioned as follows, can only enjoy the paid service even if the product under warranty:

- The malfunctions caused by improper storage or faulty operation which are not in compliance with this user manual.
- The malfunctions caused by unauthorized transformation.
- The malfunctions caused by over-range operation.
- Have over guarantee time.
- The malfunctions caused by nature causes.

### 8.2 Liability exemption

Our company only takes on the liability according to our guarantee time and range. If you need more liability guarantee, you should buy proper commercial insurance from insurance company in advance. The other extended loss caused by malfunctions of our product is not within our guarantee range. Cases as follows, regardless of whether it is within guarantee time, it is not within our guarantee range. If need service, you has to pay for it.

- The malfunctions caused by improper storage or faulty operation.
- The malfunctions caused by unauthorized transformation.
- The malfunctions caused by over-range operation.
- Have been over guarantee time.
- The malfunctions caused by nature causes.
- User has not paid off the payment according to the contract.

### 8.3 Product application

- This product is not designed and produced for the case of vital importance.
- If need to apply this product in manned mobile machine, medical, aerospace, unclear energy, electric power, devices or system for submarine communications transit, please contact the sales department of our company. We do not take on the liability of the accident while this product is used in these cases without authorization.
- This product is produced under strict quality management. But we can not ensure that there will be no malfunction. If the user requires more safety requirement and reliability, standby device should be deployed. If the user need more guarantee, proper commercial insurance should be considered.

## 9 FUNCTION PARAMETER SPECIFICATION

### 9.1 Basic parameters

F0.00	Control mode	Setting range: 0-5	Factory set: 1
-------	--------------	--------------------	----------------

**0: V/F without PG** control voltage/frequency ratio, all can change speed. It is specially suitable for one frequency drive multi-motor application. It improves the current speed control system.

This mode is used for all speed control system while quick response and right speed control are unnecessary, or motor not clear or can't self study.

**1: VC without PG** This control mode can realize control of motor without speed feedback sensor. It is no need very correct motor parameters, and widely suitable to all kinds of load, especially used for situation like noway to auto-tuning without load

**2: Reserved.**

**3: V/F with PG** can be used for simple speed feedback control. Please set this mode when need slow respond, but right speed control, especially occasions that PG feedback does not install on motor spindle, or occasions that motor not clear or can't self study.

**4: VC with PG** can be used for situation like as speed control but unknown motor parameters or noway to self-tuning without load. This control mode needs optional PG card used for speed feedback.

**5: Reserved.**

**Note: 1. PG: usually means photoelectricity inspects speed pulse encoder. While use other speed inspect card, other sensor can be used for speed feedback.**

**2. While choose VC control mode, before the first running, it has to input right motor parameters and motor parameters self adjust to gain right motor parameter. Please refer to details of F5 parameter groups.**

**3. Rightly setting VC control parameters to ensure good stable and dynamic control performance. For VC control parameter setting and adjustment, please refer to details of F6 parameter groups.**

**4. While choose VC control mode, all inverters can only drive one motor, and the capacitance rating difference between the inverters and the motor can't be too large. The inverter can be 2 rating bigger or 1 rating smaller than the motor. Otherwise, it will descend the control performance. Or the drive system can't run normally.**

**5. While choose VC with PG or V/F with PG control, must rightly set [F5.15--F5.17] parameters.**

**6. While choose V/F control mode, must rightly set V/F control parameters F8.**

F0.01	Reserved		
-------	----------	--	--

F0.02	Run command channel	Setting range: 0-4	Factory set: 0
-------	---------------------	--------------------	----------------

It is channel for inverter receiving run and stop order and run direction. It is only used for starting and stopping control under torque control.

**0: Keyboard control** Inverter run and stop is controlled by keyboard key **FWD, REV/JOG, STOP/RESET, REV/JOG** key is defined as reverse while [F4.02] set as "0" and jog while [F4.02] set as "1". Please refer to details of [F4.02].

**1: Terminal control** Factory default as two line mode 1 control mode. Under two line mode 1, inverter run, stop and direction is controlled by whether "FWD" or "REV" set for [F2.00-F2.07] "multi function input terminal" connects to control board terminal (COM) or not. "FWD" and "REV" definition refer to [F2.00-F2.07]. While under other control mode,

run, stop and direction refer to [F2.12].

**2: RS485 communication control** Inverter run, stop and direction is controlled by the signal received by RS485 communication terminal. Details refer to Fd communication control parameter group and appendix 2: RS485 communication protocol.

**3: Optional card** Inverter run, stop and direction is controlled by the signal received by optional card input signal. For the optional card installation, parameter setting and soon, please refer use manual packing with the optional card.

**4: Terminal switching** Run command is selected by 'run command switch terminal', 'run command switch terminal' is defined by any multi-function terminal, see parameter [F2.00-F2.06]; corresponding relation between the terminal state and run command channel is in the table below.

**Note: 1. While fault reset, key STOP/RESET, control terminal reset order and RS485 communication terminal are valid reset order.**

**2. While inverter input frequency is 0Hz or lower than min output frequency [F1.26]. As long as you input run order, keyboard FWD indicator will be on, the motor will run as 0 frequency.**

**Clew: keyboard key STOP/RESET function can be selectable. Under exterior terminal control or communication control, it can be defined as stop function. Please refer to [F4.03]. Under exterior terminal control, if use STOP/RESET to stop, inverter stops and close exterior terminal run order. It needs to input exterior terminal stop order and unlock. The exterior terminal run order will be valid again. So is the communication control.**

F0.03	Frequency give main channel selection	Setting range: 0-12	Factory set: 0
-------	---------------------------------------	---------------------	----------------

It is used to select frequency given gain channel. The main and assistant channels relationship can be defined by parameter [F0.07].

**0: Keyboard number setting** Given frequency of the main channel is given and modified by [F0.08] keyboard numbers setting frequency. While parameter [F4.04] LED "0" digit "keyboard up/down key modification selection" is set as "1", no matter inverter is run or stop, [F0.08] setting value can be quickly modified by keyboard up/down key directly. Whether store the value modified by the shortcut key is decided by [F4.04] LED "00" digit.

**1: Keyboard potentiometer given** Main channel given frequency is given and modified by keyboard potentiometer. Please refer to [F4.07-F4.10] details for the relationship between keyboard potentiometer and frequency.

**2: Terminal VS voltage analog** Main channel given frequency is given and modified by (VS) input analog. Please refer to [F3.00-F3.04] details for the relationship between input analog filter time and frequency.

**3: Terminal AI analog** Main channel given frequency is given and modified by (AI) input analog. Please refer to [F3.05-F3.09] details for the relationship between input analog filter time and frequency.

**4: Terminal AS current analog** Main channel given frequency is given and modified by (AS) input analog. Please refer to [F3.10-F3.14] details for the relationship between input analog filter time and frequency.

**5: Terminal pulse signal** Main channel given frequency is given and modified by (PUL) input pulse signal. Please refer to [F2.16-F2.21] details for the relationship between input pulse signal and frequency.

**6:RS485 communication port:** Main channel given frequency is given and modified by the signal accepted by RS485 communication port (A+) and (B-). Please refer to Fd communication control parameter groups and appendix 2: RS485 communication protocol details.

**7: UP/DOWN control** Main channel given frequency is given and modified by if UP terminal is connected to DOWN terminal or not, what is set by multi-function terminals (X1-X8). Anyone of the (X1-X8) terminals can be defined as UP and DOWN. Please refer to [F2.00-F2.07] details. UP, DOWN store and clear mode after adjustment can be set by [F2.22]. Please refer to [F2.22] details. ACC AND DEC of UP/DOWN control running given frequency is set by [F2.23]. UP/DOWN variation frequency can be cleared to 0 at any time by "UP/DOWN clear 0" terminal. Details see

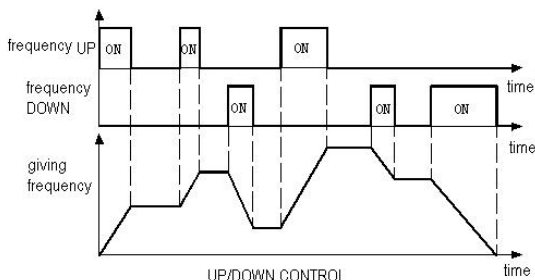
**[F2.00-F2.07].**

**8: PID control given** This channel is selected for PID closed loop control system. PID control is the control mode makes feedback the same as the target. Refer to PID control parameters "Fb".

Under this mode, while **[F4.04]** LED "0" digit is set as 3 by keyboard UP/DOWN key; **[Fb.01]** can be modified by UP/DOWN key. Whether save the modification is decided by **[F4.04]** LED "00" digit.

PID control state and trait are changed by multifunction terminals. Details refer to **[F2.00-F2.07]**.

**9: Program control (PLC) given** Main channel given frequency and frequency running direction is controlled by inner simple PLC control. Max 15 steps speed can be process control. Details see "FC" multi step, PLC function and swing frequency parameter group. If one step speed running time is set as "0", it will jump over this step. It is convenient to set step speed. While **[F0.07]** LED "00" digit is 0, frequency control direction is invalid. While **[F0.16]** is set as 2—REV forbid and any step direction is set as REV, this step run as 0 speed. PLC and multi steps speed are both for frequency inverter vary speed and run under certain rules. Under multi steps running, step switch and direction change is control be the different combination between multi step control terminal and COM defined by multifunction input terminals. PLC not only can define one cycle of multi steps frequency in the function parameters. It can also define the run time, direction, ACC/DEC time and cycle mode of multi steps in the function parameters. Multi steps control terminal can be defined by any multifunction terminal. Details refer to **[F2.00-F2.07]**.

**10: Reserved**

**11: Optional card** Main channel given frequency is controlled by input signal by optional card. For optional card installation, parameter setting please refers to user manual.

**12: Terminal switch** Frequency setting main channel is selected by frequency selection terminal which can be defined by any multi function terminal. See **[F2.00-F2.07]** please. Relation table between terminal state and frequency setting channel:

Frequency setting selection terminal 4	Frequency setting selection terminal 3	Frequency setting selection terminal 2	Frequency setting selection terminal 1	Frequency setting channel
OFF	OFF	OFF	OFF	Keyboard number give
OFF	OFF	OFF	ON	Keyboard potentiometer give
OFF	OFF	ON	OFF	Voltage analog VS give
OFF	OFF	ON	ON	Analog AI give
OFF	ON	OFF	OFF	Voltage analog AS give
OFF	ON	OFF	ON	Terminal pulse PUL give
OFF	ON	ON	OFF	RS48 communication give
OFF	ON	ON	ON	UP/DOWN control
ON	OFF	OFF	OFF	PI D control give
ON	OFF	OFF	ON	PLC give
ON	OFF	ON	OFF	Reserved
ON	OFF	ON	ON	Optional card

Combination details refer to multistep speed time order of "FC" parameter.

**Note: valid combination of frequency selection terminal is 0-11(algorithm). Frequency inverter will output 0.00Hz**



if not within this range. "OFF" in the table means invalid. "ON" means valid.

F0.04	Main channel gain	Setting range: 0.000-5.000	Factory setting: 1.000
-------	-------------------	----------------------------	------------------------

It is used to magnify or reduce the main channel input signal, can adjust given frequency of main channel at prorate.

F0.05	Frequency give auxiliary channel selection	Setting range: 0-6	Factory setting: 1
-------	--	--------------------	--------------------

It is used to select auxiliary channel for frequency given, directly control or impact output frequency of frequency inverter. Relationship between main channel and auxiliary channel can be defined by [F0.07].

**0: Keyboard number setting** Given frequency of auxiliary channel is given and modified by [F0.08] keyboard number set frequency. While [F4.04] LED "0" digit is set as 1 by UP/DOWN key, [F0.08] can be quick modified by UP/DOWN key whether frequency inverter is running or stop. Whether save is decided by [F4.04] LED "00" digit.

**1: Keyboard potentiometer** Given frequency of auxiliary channel is given and modified by potentiometer. Detail refer to [F4.07-F4.10].

**2: Terminal VS voltage analog** Given frequency of auxiliary channel is given and modified by control terminal (VS). Input analog. Detail refer to [F3.00-F3.04].

**3: Terminal AI analog** Given frequency of auxiliary channel is given and modified by control terminal (AI).input analog. Detail refer to [F3.05-F3.09].

**4: Terminal AS current analog** Given frequency of auxiliary channel is given and modified by control terminal (AS).input analog. Detail refer to [F3.10-F3.14].

**5: Terminal pulse signal** Given frequency of auxiliary channel is given and modified by control terminal (PUL).input analog. Detail refer to [F2.16-F2.21].

**6: RS485 communication** Given frequency of auxiliary channel is given and modified by signal accepted by RS485 communication port (A+) and (B-) input analog. Detail refer to Fd communication control parameter group and appendix 2: RS485 communication protocol.

F0.06	Auxiliary channel gain	Setting range: 0.000-5.000	Factory set: 1.000
-------	------------------------	----------------------------	--------------------

It is used to magnify or reduce the main channel input signal, can adjust given frequency of main channel at prorate.

F0.07	Frequency give channels combinations mode	Setting range: 0000-0016	Factory set: 0000
-------	---	--------------------------	-------------------

**LED "0" digit: omination mode selection** It is used to select the combination of the main input channel and the auxiliary input channel of the give frequency.

**0: Main channel valid** Only main channel [F0.03] is valid, auxiliary channel [F0.05] is invalid.

**1: Auxiliary channel valid** Only auxiliary channel [F0.05] is valid, main channel [F0.03] is invalid.

**2: Main+auxiliary** The sum of main channel [F0.03] add auxiliary channel [F0.05] is the output frequency of the inverter.

**3: Main-auxiliary** The result of main channel [F0.03] minus auxiliary channel [F0.05] is the output frequency of the inverter.

**4: MAX {main, auxiliary}** The bigger one of main channel [F0.03] and auxiliary channel [F0.05] is the output frequency of the inverter.

**5: MIN {main, auxiliary}** The smaller one of main channel [F0.03] and auxiliary channel [F0.05] is the output frequency

of the inverter.

**6: Main\*auxiliary** Given frequency of main channel [F0.03] multiply certain percent which is percent of given frequency of auxiliary channel [F0.05] responding to max frequency [F0.09]. The result is output frequency of the frequency inverter.

**LED "00" digit: frequency control direction selection** It is used to select whether permit negative frequency change the running direction of the frequency inverter while the result is negative.

**0: invalid** If result is negative, frequency inverter output 0.00Hz.

**1: valid** If result is negative, frequency inverter change running direction and output relative frequency.

**LED "000" digit: reserved**

**LED "0000" digit: reserved**

**Note: 1. While main\*auxiliary, frequency only count positive value. While any channel frequency is negative, count as 0.00Hz, frequency inverter output 0.00Hz.**

**2. Can't main\*auxiliary while JOG and multi step speed running.**

**3. While rotate direction selection [F0.16] is set as REV forbid, whatever frequency control direction selection is set, frequency inverter outputs 0.00Hz frequency if count result is negative.**

**Note: Given frequency synthesized by main channel and auxiliary channel also limited by upper limit frequency and lowest limit frequency.**

F0.08	Keyboard number set frequency	Setting range: 0-upper limitation	Factory set: 50.00Hz
-------	-------------------------------	-----------------------------------	----------------------

While frequency give channel is keyboard numbers, it is used to set and modify frequency. If [F4.04] LED "0" digit is 1, the up/down key can modify the parameter value. Where save the modify after power off is decided by [F4.04] LED "00" digit.

F0.09	Max frequency output	Setting range: 0.00-320.00Hz	Factory set: 50.00Hz
F0.10	Upper limitation source selection	Setting range: 0.000-0016	Factory set:0000
F0.11	Number give upper limitation	Setting range: Lowest limitation-max output frequency	Factory set: 50.00Hz
F0.12	Lowest limitation	Setting range: 0.00-upper limitation	Factory set: 0.00Hz
F0.13	Lowest limitation run mode	Setting range: 0-1	Factory set: 1

**Max frequency output:** The max frequency the frequency inverter permit to set. While [F1.13] LED "0" digit is 0, it is also the base of ACC/DEC time setting.

**Upper limitation source selection:** To select the give source of upper frequency limitation of frequency inverter. It is the max output frequency limitation set according to the machinery max rotate speed.

**0: Number give** Upper limitation set by [F0.11]. Max setting is small or equal to max frequency [F0.09]. Min setting is bigger or equal to min frequency [F0.12].

**1: Keyboard potentiometer** Upper limitation set by keyboard potentiometer.

**2: Terminal VS voltage analog** Upper limitation set by VS input analog .

**3: Terminal AI voltage analog** Upper limitation set by AI input analog.

**4: Terminal AS current analog** Upper limitation set by AS input analog.

**5: Terminal pulse signal** Upper limitation set by PUL input pulse frequency.

**6: RS485 communication** Upper limitation set by RS485 communication (H3004/H2004).Max set not over max

frequency [F0.09]. Min set not lower than [F0.12]. Details refer to Fd communication control parameter group and appendix 2: RS485 communication protocol.

**Note: Relation between input analog or PUL pulse frequency and upper limit frequency: when input max valid value, upper limit frequency is max frequency [F0.09]. When input min valid value, upper limit frequency is 0.00Hz.**

**Number give upper limitation:** It is upper limit frequency given channel when [F0.10] is set as 0.

**Lowest limitation:** It is the lowest limitation of output frequency. While given frequency is lower than this value, [F0.13] decides the run frequency.

#### Lowest limitation run mode

**0: Stop** When actual given frequency is lower than the lowest limitation, inverter run as 0.00Hz.

**1: Run as lowest limitation** When actual given frequency is lower than the lowest limitation, inverter run as the lowest limitation.

**Note: 1.** While given upper limitation by analog or PUL pulse frequency, lowest limitation is invalid if upper limitation is lower than lowest limitation.

- 2. Max frequency, upper limitation and lowest limitation set carefully according to actual need please.**  
 Except upper limitation and lowest limitation, inverter is also limited by parameters set such as start frequency, free stop frequency, stop DC brake start frequency, jump frequency and so on. Max frequency, upper limitation and lowest limitation relationship as below:

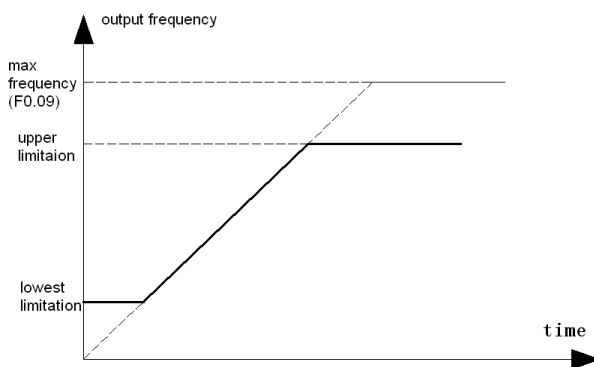

max frequency, upper limitation and lowest limitation relationship

F0.14	ACC time 1	Setting range: 0.01-650.00s	Factory set: Accord model
F0.15	DEC time 1	Setting range: 0.01-650.00s	Factory set: Accord model

**ACC time 1:** When [F1.13] LED "0" digit is 0, it means the time needed for output frequency accelerate from 0.00Hz to max frequency [F0.09]. When [F1.13] LED "0" digit is 1, it means the time needed for output frequency accelerate from 0.00Hz to 50.00Hz. Details refer to [F1.13].

**DEC time 1:** When [F1.13] LED "0" digit is 0, it means the time needed for output frequency decelerate from max

frequency [F0.09] to 0.00Hz. When [F1.13] LED "0" digit is 1, it means the time needed for output frequency decelerate from 50Hz to 0.00Hz. Details refer to [F1.13].

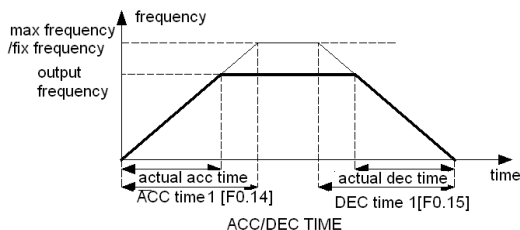

This frequency inverter can set 4 kinds of ACC/DEC time max. If need to select other ACC/DEC time group, it must to select by control terminal. Details refer to [F2.00-F2.06] and [F1.18-F1.23].

ACC time is only valid for normal speed up process, not including start per-excite, start DC brake time and start frequency hold time. DEC time is only valid for normal speed down process, not including stop DC brake time.

During process running, ACC/DEC time 1 is defined as first kind of ACC/DEC time. The other 3 kinds of ACC/DEC time details refer to [F1.18-F1.23] please.

JOG ACC/DEC time set by [F1.33, F1.34] alone.

F0.16	Rotate direction	Setting range: 0-2	Factory set: 0
-------	------------------	--------------------	----------------

**0: Consistant** The actual run direction is the same as required. Not adjust the current direction.

**1: Reverse** The actual run direction is reverse to requirement. Adjust the current direction.

**2: Forbid reverse** While it is set as forbid, the reverse order of all run order channels (operation board, exterior terminal, RS485 communication, optional card and program running) is invalid.

When frequency setting is negative (including that after combination), no matter what is [F0.07] LED "00" digit (frequency control direction), the actual output frequency is limited as 0.00Hz.

**Note: While reset to factory set, this setting is not changed.**

**Attention: All reverse order is forbid. If give reverse order, the frequency inverter not run.**

F0.17	Carrier frequency	Setting range: 0.6-15.0kHz	Factory set: Accord model
-------	-------------------	----------------------------	---------------------------

It is used to set IGBT frequency, adjust electromagnetic noise, reduce leakage current. It is suitable for location need mute when run in high carrier frequency, main parts loss heavy. Machine is heat heavy. Effect is reduced. And power out small. Maintenance, radio disturbance is heavy. And capacitance leak current more, if there is leak protection, maybe there is mistake action or over current.

While run in low carrier frequency, the case will be totally different. The best carrier frequency comes with adjustment based on actual case. The bigger the capacity, the smaller the carrier frequency should be.

We reserve the right of the biggest carrier frequency limitation.

Carrier frequency	noise	disturbance	Radiator temperature
low	big	Small	Small
↓	↓	↓	↓
high	small	big	big

**Note: We advice ratio of carrier frequency to max frequency not lower than 36. If work under low frequency long time, we advice reduce carrier frequency to reduce the dead area time impact.**

**Attention: while carrier frequency is higher than the factory set, the rated power reduce 5% if carrier frequency add 1kHz.**

F0.18	Carrier PWM frequency characteristic selection	Setting range: 0000-2111	Factory set: 0010
-------	--	--------------------------	-------------------

LED "0" digit:

**0: Related to temperature**

**1: Not related to temperature**

While temperature is too high, frequency inverter reduces carrier frequency automatic. Can reduce loss and avoid frequent alarm for over heat.

LED "00" digit:

**0: Related to frequency output**

**1: Not related to frequency output**

While carrier frequency is related to frequency output, it can automatic adjust carrier frequency according to frequency output. It can improve low frequency performance and high frequency mute effect.

LED "000" digit:

**0: Fixed PWM** Noise frequency is fixed.

**1: Random PWM** It can make humorous wave of output voltage distributes a wide range evenly to reduce noise and vibration.

LED "0000": PWM wave mode

**0: PWM mode 1** It output high quality sine wave while low speed to gain good low frequenc trait, low noise. It reduce parts on/off times to reduce loss while high speed. But the noise is big.

**1: PWM mode 2** It gains high quality current wave. Noise is small, but loss is big and temperature rise up high.

**2: PWM mode 3** It can reduce parts on/off times, reduce temperature rice up, but the noise is big.

F0.19	Parameter initialization	Setting range: 0-2	Factory set: 0
-------	--------------------------	--------------------	----------------

0: Not act

1: Recover factory setting

2: Clear malfunction records Clear all [FA.25-FA.44] mistake history.

**Note:**

**1. Keyboard shows SRVE while recover factory setting. SRVE disappear while initialization finished.**

**2. Not change [F0.16] and [F4.11-F4.14] setting while recover factory setting.**

**3. If power off while recover factory setting. It can not finish. It need recover after power on again.**

F0.20	AVR function selection	Setting range: 0-4	Factory set: 2
-------	------------------------	--------------------	----------------

0: Invalid

1: All valid

2: Invalid while ACC, valid while other state

3:Quick AVR adjust, all valid

4:Quick AVR adjust, invalid while DEC, valid while other state

AVR function is automatic output voltage adjustment function. While AVR is invalid, output voltage changes based on input voltage. While it valid, output almost keeps as setting value if minimum input voltage wave is bigger than output voltage setting (motor rated voltage) or output voltage reduces based on input voltage down if power voltage is lower than rated output voltage.

Quick AVR function is better than normal AVR function to restrain OC caused for quick bus voltage up. But it maybe brings current vibration caused by frequent bus voltage wave.

F0.21	Over-exciting while DEC	Setting range: 0-1	Factory set: 0
F0.22	Over-exciting current	Setting range: 50.0%-200.0%	Factory set:115.0%
F0.23	Over-exciting gain	Setting range:0.0-100.0	Factory set:Accord model

**Over excitation while DEC:**

0: Invalid

1: Valid

Over excitation setting current: used for setting over exciting current while inverter decelerates.This function can realize more quickly to stop motor than general DEC stop mode by adding flux of motor when DEC,even if no optional braking resistance.Over exciting current calculation formula as below:

$$\text{Over exciting current} = \text{motor rated current} \times \text{Over exciting setting current}$$

The best value of over exciting current while DEC is different according to magnetic saturation of motor. Please increase **[F0.22]** in range 50.0-200.0% in order to improve braking characterstic.

If setting value is too big, it may get E.OC, E.OL1 and E.OL2 caused by magnetic saturation.Then please decrease setting value of **[F0.22]**.

**Over exciting gain:** It is used for adjusting speed of exciting magnetic building while inverter decelerates.This function can keep exciting flux stability, and stop motor quickly.

Because of exciting magnetic building needing some time, inverter may trip out and display E.OC easily caused by exciting current overshoot.So you must set and adjust it according to model

**Note:**

1. If you use the function frequently,it may cause temperature rising of motor,because of regenerative energy is used by motor as heat. Please keep motor temperature below allowed maximum.If you need to start and stop inverter quickly, frequently, but consider of motor protection, please select optional braking resistance corresponding to inverter powe range
2. Inverter should decelerate to stop according to setting valid time.Please set DEC time in case of E.OU2 fault
3. If running order is coming when inverter is in over exciting while DEC,Over exciting function may be canceled,and inverter will accelerate to setting frequency again.

## 9.2 Run control parameter

F1.00	Start-up mode	Setting range: 0-2	Factory set: 0
F1.01	Start pre-excitation time	Setting range: 0.00-60.00s	Factory set: Accord model
F1.02	Start frequency	Setting range: 0.00-60.00Hz	Factory set: 0.50Hz
F1.03	Start frequency hold time	Setting range: 0.0-50.0s	Factory set: 0.0s
F1.04	Braking current before start	Setting range: 0.0-150.0%	Factory set: 0.0%
F1.05	Braking time before start	Setting range: 0.0-30.0s	Factory set: 0.0s

### Start-up mode

**0: Start by start-up frequency [F1.02]** start-up frequency and **[F1.03]** start-up frequency hold time control the frequency inverter start. It is suitable for big static friction torque and small load inertia occasion or occasion with exterior machine brake equipment. Motor spindle can keep static before restart after stop.

**1: DC brake and start. Firstly [F1.04]** brake current and **[F1.05]** brake time give certain energy to motor with load (electromagnetic hold brake). Then start by start-up frequency. It is suitable for stop state, small inertia load with REV and FWD.

**2: Speed track, direction judge and start** Detect speed and direction firstly, then start as the speed detected out and run to given frequency according to ACC/DEC time. Speed tracking modes include inner speed tracking and exterior speed tracking, and you can select by setting **[F1.37]** Note: Only software speed tracking below 2.2kw.

**Start pre-excitation time:** It is used to set pre-excitation time for asynchronism motor while start. It can improve start performance and reduce start current and start time.

**Start frequency:** It is the initial output frequency while start. Right start frequency can bring big start torque. While start, certain instant force can be brought for load with big static friction under static state.

**Start frequency hold time:** How long the start frequency be hold.

**Braking current before start:** It is the braking current that the inverter gives the motor while DC braking. It is based on the output rated current of the inverter. Only when **[F1.00]** is 1, there is DC braking while start.

**Braking time before start:** It is the time that DC braking current hold while start. Only when **[F1.00]** is 1, there is DC braking while start. There is no DC braking while braking time is 0.0s.

**Attention: Start frequency is not limited by [F0.12], but limited by [F1.26] min output frequency. If setting is smaller then [F1.26], the output frequency is 0.00Hz.**

**Note:** Under process of REV/FWD switch while normal running or process of frequency setting change while up/down running, frequency inverter starts from or reduces to min output frequency **[F1.26]** and than output 0.00Hz.

**Note:** In process of inverter start ACC, inverter output 0 when given frequency is small then start frequency.

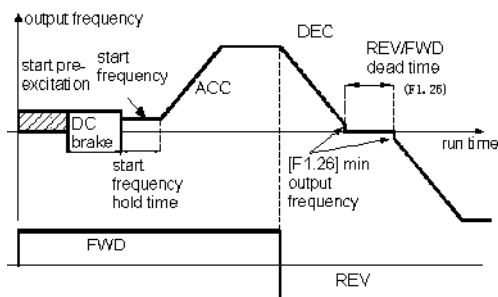

START UP FIG

F1.06	Speed track waiting time	Setting range: 0.00-60.00s	Factory set: Accord model
-------	--------------------------	----------------------------	---------------------------

It is defined as the waiting time before speed tracking while receiving the run order. After this time, inverter runs to give frequency according to the frequency and direction detected out and the ACC/DEC time setting.

For big inertia load, prolong speed track waiting time to reduce the instant impact current.

F1.07	Stop mode	Setting range: 0-1	Factory set: 0
-------	-----------	--------------------	----------------

**0: DEC to stop** ACC to 0.00Hz and stop output. While give frequency is small then stop DC braking start frequency [F1.08], inverter output frequency will change to 0. DC brake and stop work. Otherwise inverter will DEC to min output frequency and stop work.

For inverter with build in braking unit (under than AC80C-T3-018G), braking resistance(optional) can be used. When DC bus voltage is over [FA.07] energy braking act voltage, inverter begins to carry out the energy braking act.

For inverter without build in braking unit (upper than AC80C-T3-022G), braking unit and braking resistance can be selected. It is mainly used for occasion that need quick braking while stop.

**1: Free stop** Inverter stop output while receiving the stop order. Usually, it cooperates with exterior machine hold brake.

F1.08	Initial frequency of stop DC braking	Setting range: 0.00-50.00Hz	Factory set: 0.00Hz
F1.09	Stop DC braking current	Setting range: 0.0-150.0%	Factory set: 0.0%
F1.10	Waiting time of stop DC braking	Setting range: 0.0-60.0s	Factory set: 0.0s
F1.11	Stop DC braking duration	Setting range: 0.0-60.0s	Factory set: 0.0s

**Initial frequency of stop DC braking:** While inverter DEC to this frequency, it will stop output and start DC braking.

**Stop DC braking current:** It is the current that inverter give motor while DC braking. It is based on the output rated current of the inverter. DC braking can afford 0 speed torque. It is usually used for improve stop accuracy and quick stop. It can't be used for DEC braking for normal running.

**Waiting time of stop DC braking:** It is the time for waiting to DC braking while inverter DEC to initial frequency of stop DC braking and stop output.

**Stop DC braking duration:** It is DC braking current holding time after stop. It is no DC braking process while braking time is 0.0s.



F1.12	Reserved		
-------	----------	--	--

F1.13	ACC/DEC mode selections	Setting range: 0000-0011	Factory set: 0000
F1.14	Start ACC rate of S curve	Setting range: 20.0%-100.0%	Factory set: 50.0%
F1.15	Start DEC rate of S curve	Setting range: 20.0%-100.0%	Factory set: 50.0%

### ACC/DEC mode selections

#### LED "0" digit: ACC/DEC time base

0: max frequency Base is max frequency [F0.09]

1: fixed frequency Base is 50.00Hz

#### LED "00" digit: ACC/DEC mode

0: Beeline Suitable for general used load.

1: S Curve Suitable for load need reduce noise, vibration, impact or load need descend torque for low frequency and ACC short time for high frequency. If over current or over load while start, please increase [F1.14] setting.

#### LED "000" digit: reserved

#### LED "0000" digit: reserved

**Start ACC rate of S curve:** It is the rate while start ACC. The smaller the rate is, the ACC S curve is sharper. Otherwise, The bigger the rate is, the ACC S curve is more like a beeline. If you want it ACC more smoothly, you can reduce the rate and prolong ACC time.

**Start DEC rate of S curve:** It is the rate while start DEC. The smaller the rate is, the DEC S curve is sharper. Otherwise, The bigger the rate is, the ACC S curve is more like a beeline. If you want it DEC more smoothly, you can reduce the rate and prolong DEC time.

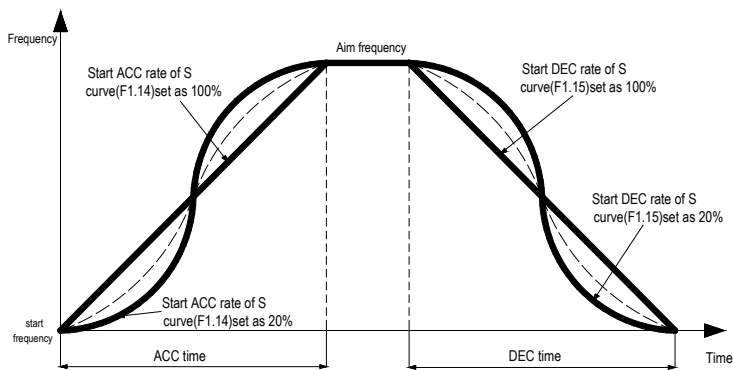

ACC/DEC curve

**Note:** ACC /DEC time will not be changed when modifying F1.14 and F1.15.

F1.16-F1.17	Reserved		
-------------	----------	--	--

F1.18	ACC time 2	Setting range: 0.01-650.00s	Factory set: 10.00s
F1.19	DEC time 2	Setting range: 0.01-650.00s	Factory set: 10.00s
F1.20	ACC time 3	Setting range: 0.01-650.00s	Factory set: 10.00s
F1.21	DEC time 3	Setting range: 0.01-650.00s	Factory set: 10.00s

F1.22	ACC time 4	Setting range: 0.01-650.00s	Factory set: 10.00s
F1.23	DEC time 4	Setting range: 0.01-650.00s	Factory set: 10.00s

**ACC time 2/3/4:** When [F1.13] LED "0" digit is 0, it means the time need for output frequency ACC from 0.00Hz to max frequency [F0.09]. When [F1.13] LED "0" digit is 1, it means the time need for output frequency ACC from 0.00Hz to 50.00Hz. Details refer to [F1.13].

**DEC time 2/3/4:** When [F1.13] LED "0" digit is 0, it means the time need for output frequency DEC from max frequency [F0.09] to 0.00Hz. When [F1.13] LED "0" digit is 1, it means the time need for output frequency DEC from 50.00Hz to 0.00Hz.

ACC/DEC time details refer to [FC.31-FC.45].

JOG ACC/DEC time is set by [F1.33, F1.34]

ACC/DEC time table:

Terminal 2	Terminal 1	ACC/DEC time
OFF	OFF	ACC/DEC time 1
OFF	ON	ACC/DEC time 2
ON	OFF	ACC/DEC time 3
ON	ON	ACC/DEC time 4

If any unclear, please see FC parameter group multi steps time order fig.

F1.24	Emergency stop DEC time	Setting range: 0.01-650.00s	Factory set: 10.00s
-------	-------------------------	-----------------------------	---------------------

Same as ACC/DEC time definition.

Emergency stop can be take effect by emergency stop terminal, details refer to [F2.00-F2.07]. While terminal control two line run, whether carry out the original run order is decided by [F2.13] LED "00" digit. Details refer to [F2.13].

If [FA.01] "000" and "0000" digit is 1 emergency stop, the inverter will DEC to stop according this time and alarm fault. Details refer to [FA.01].

While multifunction terminal is set as emergency stop, refer to detail [F2.29-F2.31].

F1.25	FWD&REV dead area	Setting range: 0.0-120.0s	Factory set: 0.0s
F1.26	Min output frequency	Setting range: 0.00-60.00Hz	Factory set: 0.40Hz

**FWD&REV dead area:** Waiting time at 0.0Hz while switch between FWD/REV. It sets for equipment with machine dead area while big inertia load and change direction.

**Min output frequency:** If lower than this frequency, inverter output 0.00Hz

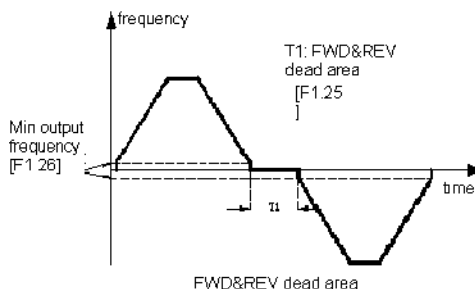

F1.27	0 speed hold torque	Setting range: 0.0-150.0%	Factory set: 0.0%
-------	---------------------	---------------------------	-------------------

Set output torque at 0 speed.

F1.28	0 speed hold torque time	Setting range:0.0-6000.0s	Factory set: 5.0s
-------	--------------------------	---------------------------	-------------------

Set output torque keep time at 0 speed. Count from 0Hz, stop output while arrive this set time. Valid count value range is 0-5999.9s. Frequency inverter counts as setting while it is within valid range and stop 0 speed hold torque while time finished.

If set as 6000.0s, frequency inverter will not count, default as 0 speed hold torque always valid and only stop while stop or give running frequency not 0.

Suitable 0 speed hold torque time setting can save energy effectively and protect motor.

**Note: Please pay attention to motor temperature rise while 0 speed hold torque time is too long or 0 speed hold torque is too big. If temperature rises too high, it needs add equipment to improve motor radiation.**

F1.29	Power off restart action selection	Setting range: 0-1	Factory set: 0
F1.30	Power off restart waiting time	Setting range: 0.00-120.00s	Factory set: 0.50s

#### Power off restart action selection

**0: invalid** Only run with order power on again. While keyboard control, RS485 communication control or optional card control, automatic clear running order while power off.

While exterior terminal control, run as [F1.31] setting.

**1: Valid** If inverter is at run state before power off, it start automatically after [F1.30] waiting time. While waiting, it does not accept any orders. But if stop order, it will not restart.

**Note: It can make machine automatic re-start while power recovers. Please use it carefully.**

**Power off restart waiting time:** While [F1.29] is valid, inverter restarts after [F1.30] waiting time.

F1.31	Terminal running protection selection	Setting range :0000-0011	Factory set: 0001
-------	---------------------------------------	--------------------------	-------------------

#### LED "0" digit: while electrify

**0: Terminal running order invalid while electrify** Terminal controls stop firstly, then start.

**1: Terminal running order valid while electrify** Terminal controls start directly

#### LED "00" digit: while switch the run order give channel

**0: invalid** Terminal controls stop firstly, then start.

**1: valid** Terminal controls start directly.

F1.32	JOG running frequency setting	Setting range: 0.00-Max frequency	Factory set: 5.00Hz
F1.33	JOG ACC time	Setting range: 0.01-650.00s	Factory set: 10.00s
F1.34	JOG DEC time	Setting range: 0.01-650.00s	Factory set: 10.00s

**JOG running frequency setting:** Set output frequency while JOG.

**JOG ACC time:** When [F1.13] LED "0" digit is 0, it means the time need for output frequency ACC from 0.00Hz to max frequency [F0.09]. When [F1.13] LED "0" digit is 1, it means the time need for output frequency ACC from 0.00Hz to 50.00Hz. Details see [F1.13].

**JOG DEC time:** When [F1.13] LED "0" digit is 0, it means the time need for output frequency DEC from max frequency [F0.09] to 0.00Hz. When [F1.13] LED "0" digit is 1, it means the time need for output frequency DEC from 50.00Hz to 0.00Hz.

**Note:** JOG run frequency set is only limited by [F0.09]. While JOG frequency setting is bigger then [F0.11] upper limitation, actual JOG output frequency is limited by upper limitation. Only terminal JOG priority is not limited by run orger channels. Other JOG orders have priority only while the channel is tha same as others. Such as keyboard JOG is only valid under keyboard control.

F1.35	Jump frequency	Setting range: 0.00-Max frequency	Factory set: 0.00Hz
F1.36	Jump frequency range	Setting range: 0.00-Max frequency	Factory set: 0.00Hz

**Jump frequency:** While running, the frequency avoid running.

**Jump frequency range:** The up/down frequency range of [F1.35] avoid running. It can be used for output frequency to avoid machine load resonance point.

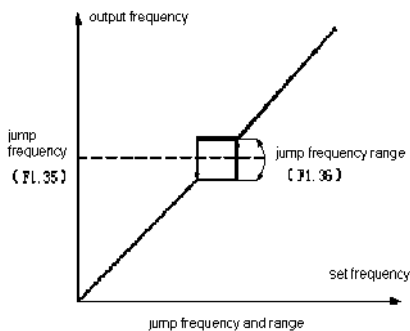

**Note:** Output frequency will through jump frequency area while ACC/DEC.

F1.37	Speed tracking selections	Setting range:0000-0011	Factory set: 0000
F1.38	Speed of speed tracking	Setting range: 0.00-1.00%	Factory set: 0.05%
F1.39	Voltage restore time	Setting range: 0.10-10.00s	Factory set: 0.60s
F1.40	Speed tracking action current	Setting range: 1.0-200%	Factory set: According to model

### Speed tracking function selections:

#### LED"0"digit: way of speed tracking

- 0. Hardware speed tracking      checking speed of motor by hardware circuit
- 1. Software speed tracking      checking speed of motor by software calculation

#### LED"00"digit: Direction of speed tracking

- 0: Search in single direction      Search only in the record direction when it stops

1. Search in bidirection      Search both ways

LED"000"digit: Reserved

LED"0000"digit: Reserved

It can detect motor speed from current that is named software speed tracking.It will restore voltage according to (F1.39) voltage rising time when running at upper limit or setting frequency.Inverter will decrease output frequency at a speed of (F1.38)tracking speed,when output current is bigger than (F1.40) setting value;When current is lower than F1.40,inverter will think that output frequency is the same as motor speed and then accelerate or decelerate to setting frequency. Software speed tracking figure as below:

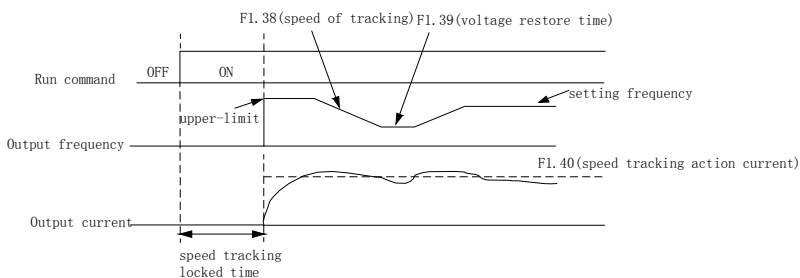

### 9.3 Quantum digital terminal functions

F2.00	Multifunction input terminal 1(X1)	Setting range: 0-63	Factory set:1
F2.01	Multifunction input terminal 2(X2)		Factory set:2
F2.02	Multifunction input terminal 3(X3)		Factory set:4
F2.03	Multifunction input terminal 4(X4)		Factory set:5
F2.04	Multifunction input terminal 5(X5)		Factory set:6
F2.05	Multifunction input terminal 6(X6)		Factory set:8
F2.06	Multifunction input terminal 7(X7/PUL)		Factory set:0

Machine has seven multifunction terminals(X1-X7) which can be defined by [F2.00-F2.06]. And trait and filter time can be defined by [F2.08-F2.11]. Setting and function table:

setting	setting	setting	setting
0	No function( can choose again)	24	PID trait switch
1	FWD	25	PID give switch 1
2	REV	26	PID give switch 2
3	3 line run control(Xi)	27	PID give switch 3
4	FWD JOG	28	PID feedback switch 1
5	REV JOG	29	PID feedback switch 2
6	Free stop	30	PID feedback switch 3
7	Emergency stop	31	PLC pause
8	Fault reset	32	PLC restart
9	Out fault input	33	Reserved
10	Frequency (UP)	34	Reserved
11	Freuqncy (DW)	35	Reserved
12	(UP/DW clear )	36	Frequency channel switch terminal 1

13	Run command switch terminal1	37	Frequency channel switch terminal 2
14	Run command switch terminal2	38	Frequency channel switch terminal 3
15	Multi steps terminal 1	39	Frequency channel switch terminal 4
16	Multi steps terminal 2	40	Timer touch terminal
17	Multi steps terminal 3	41	Timer clear terminal
18	Multi steps terminal 4	42	Counter clock input terminal
19	ACC/DEC time selection terminal 1	43	Counter clear terminal
20	ACC/DEC time selection terminal 2	44	DC brake order
21	ACC/DEC pause	45	Pre-excitation order terminal
22	PID control cancel	46	Speed measuring and counter clear zero terminal
23	PID control pause	47	Reserved

**0: No function** This terminal invalid.

**1: FWD** While run order is given by terminal, and [F2.12] is set as 2 line 1, and terminal is valid, inverter will FWD. Other control mode refer to [F2.12].

**2: REV** While run order is given by terminal, and [F2.12] is set as 2 line 1, and terminal is valid, inverter will REV. Other control mode refer to [F2.12].

**3: 3 line run control (Xi)** While run order is given by terminal, and [F2.12] is set as 3 line 1/2, it is 3 line run control (Xi). Details refer to [F2.12].

**4: FWD JOG**

**5: REV JOG**

JOG refer to details [F1.32-F1.34].

**6: Free stop** While it is valid, inverter stops output. Motor will free run. While free stop terminal is always valid, inverter does not accept any start order and keep stop state. Whether recover to original order after free stop order is relieved while terminal 2 line control running, refer to [F2.13] please. It does not recover to original order after free stop order is relieved while keyboard, RS485, optional card and terminal 3 line control running. If need start inverter, it needs to input run order again.

**7: Emergency stop** If input emergency stop order while running, inverter DEC and stop according [F1.24] DEC time setting. Details refer to [F1.24]. It can not run again before totally stopping. While [F1.07] is set as free stop, emergency stop order and free stop order is same function. Once this terminal is valid, inverter stops output and free stop immediately. If emergency stop terminal is always valid, inverter does not accept start order and keep stop. Under 2 line control mode, whether recover original run order after relieve emergency stop order is decided by [F2.13]. Not recover original order under keyboard, RS485, optional card and terminal 3 line control mode. If need start inverter, please input order again.

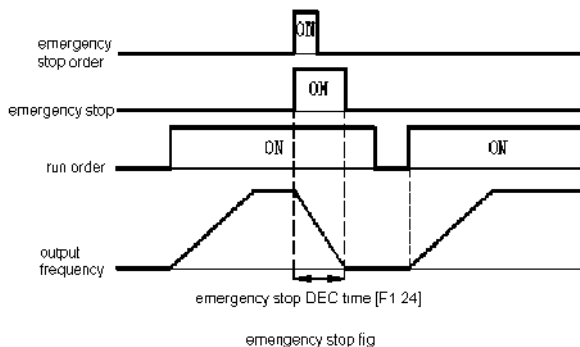

**Note:** While use emergency stop function, please set right [F1.24] DEC time or work with energy brake function. Otherwise over-voltage fault maybe happen.

**8: Fault reset** It decides whether reset fault while alarm. Whether recover original order after fault reset is decided by [F2.13].

**9: Out fault input** Inverter stop output while accept exterior fault input signal by it. Motor free run and display malfunction information E.EF.

**10: Frequency (UP)**

**11: Frequency (DW)**

Only valid while [F0.03] is set as 7. Details refer to [F0.03].

**12: (UP/DW clear)** Only valid while [F0.03] is set as 7. Details refer to [F0.03].

**13: Run command switch terminal1**

**14: Run command switch terminal2**

Valid only when parameter [F0.02] is set to "4" terminal switching control. Run command channel is selected by terminal; two terminals can be combined 0-3, respectively corresponding to [F0.02] "0-3" run command channel. See parameter [F0.02] for details.

**15: Multi steps terminal 1**

**16: Multi steps terminal 2**

**17: Multi steps terminal 3**

**18: Multi steps terminal 4**

See parameter details of multi steps and FC group of PLC.

**19: ACC/DEC time selection terminal 1**

**20: ACC/DEC time selection terminal 2**

ACC/DEC time selection terminal 1 is defaulted as valid while not set parameter and terminal invalid. Details see [F1.18-F1.23].

**21: ACC/DEC pause** In ACC/DEC process, if it is valid, inverter stop ACC/DEC and keep the speed. It is only valid while inverter is running. It is invalid for DEC stop.

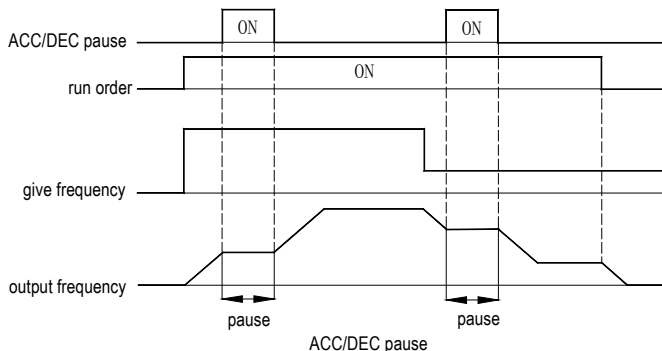

**22: PID control cancel** While [F0.03] is set as 8 and this terminal is valid, it can make PID function be invalid. Main frequency given channel give 0.00Hz. While this terminal is invalid, PID re-count frequency given of main channel.

**23: PID control pause** While PID given and this terminal is valid, it can make PID adjustment be invalid and keep frequency not change. PID re-count frequency given of main channel.

**24: PID trait switch** While [F0.03] is set as 8 and this terminal is valid, [Fb.05] LED "0" digit-trait setting will be changed. PID output trait back to [Fb.05] LED "0" digit-trait setting.

**25: PID given switch 1**

**26: PID given switch 2**

**27: PID given switch 3**

While PID controller give signal source [Fb.00] is set as 8, give signal source channel can be switched by this group of terminals. Details see [Fb.00].

**28: PID feedback switch 1**

**29: PID feedback switch 2**

**30: PID feedback switch 3**

While PID controller feedback signal source [Fb.02] is set as 8, feedback signal source channel can be switched by this group of terminals. Details refer to [Fb.02].

**31: PLC pause** While [F0.03] is 9, this valid signal can make PLC pause and inverter output 0.00Hz. Inverter go on as before while this signal disappears. See parameter details of multi steps and FC group of PLC.

**32: PLC restart** While [F0.03] is 9, this valid signal can make PLC start from the 1<sup>st</sup> step again at stop state or running. See parameter details of multi steps and FC group of PLC.

**33: Reserved**

**34: Reserved**

**35: Reserved**

**36: Frequency channel switch terminal 1**

**37: Frequency channel switch terminal 2**

**38: Frequency channel switch terminal 3**

**39: Frequency channel switch terminal 4**

It is valid only when [F0.03] is set as 12. Main frequency input channel is selected by terminal. 4 terminals can be combined to 0-11 which is corresponding to frequency input channels 0-11 of [F0.03]. Details refer to [F0.03].

**40: Timer touch terminal** Closed is valid. Detail refer to [F2.25-F2.26].

**41: Timer clear terminal** Closed is valid. Detail refer to [F2.25-F2.26].

**42: Counter clock input terminal** Detail refer to [F2.27-F2.28].

**43: Counter clear terminal** Closed is valid. Detail refer to [F2.27-F2.28].



**44: DC brake order** At stop state, it can start DC brake function. Details refer to [F1.09]. If input run order or JOG order, DC braking will be stopped.

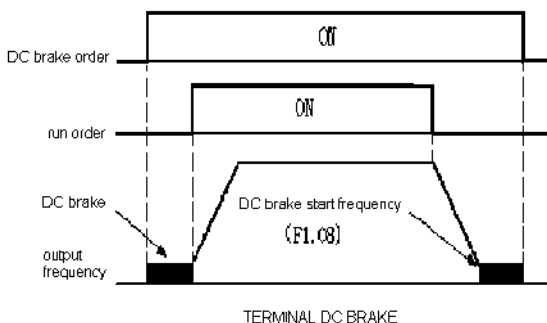

**45: Pre-excitation order terminal** At stop state, it can start pre-excitation function. If input run order or JOG order, pre-excitation order is cancelled.

**46: Speed measuring and counter clear zero terminal**

The record of speed measuring and counter clear zero valid when instant off. See in parameter [F5.28-F5.31]

**47: Reserved**

**Note:** Terminal X7 has two kinds of function, one is used as input terminal when F2.06 is not equal to 0, and the other is used as PUL input when F2.06=0.

F2.07	Reserved
-------	----------

F2.08	X1-X4 terminal trait selection	Setting range: 0000-1111	Factory set: 0000
F2.09	X1-X4 input terminal filter time	Setting range: 0.000-60.000s	Factory set: 0.010s

**X1-X4 terminal trait selection**

**LED "0" digit: X1 terminal**

0: On valid

1: Off valid

**LED "00" digit: X2 terminal**

0: On valid

1: Off valid

**LED "000" digit: X3 terminal**

0: On valid

1: Off valid

**LED "0000" digit: X4 terminal**

0: On valid

1: Off valid

**X1-X4 input terminal filter time:** When input terminal state changes, only if changed state keeps after filter time setting, it is considered as valid terminal state change. Otherwise, it keeps last state to effectively avoid misact caused by disturbance.

F2.10	X5-X7 terminal trait selection	Setting range: 0000-1111	Factory set: 0000
F2.11	X5-X7 input terminal filter time	Setting range: 0.000-60.000s	Factory set: 0.010s

Same as F2.08 and F2.09.

F2.12	Terminal control mode	Setting range: 0-3	Factory set: 0
-------	-----------------------	--------------------	----------------

**0:2-line 1** Run and direction in 1.Factory set is X1(FWD), X2(REV) terminals decide motor forward or reverse.

K1	K2	run order
0	0	stop
1	0	FWD
0	1	REV
1	1	COM

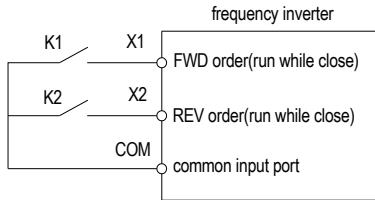

0: 2-line 1

**1:2-line 2** Run and direction is separate. FWD terminal X1 is run terminal. FWD terminal X2 state decides direction.

K1	K2	run order
0	0	stop
1	0	FWD
1	1	REV
0	1	stop

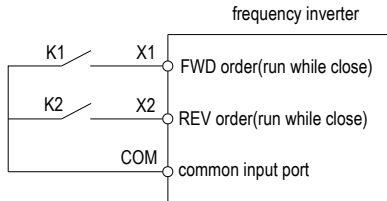

1: 2-line 2

**2:3-line 1** Xi is stop run terminal. Run order is decided by FWD terminal X1. Direction is controlled by REV terminal X2. Xi is valid input.

K1	direction control
0	FWD
1	REV

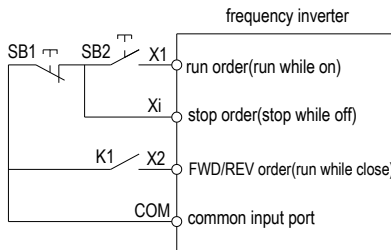

2: 3-line 1

**3:3-line 2** Xi is stop run terminal. Run order is decided by FWD terminal X1or REV terminal X2. Direction is controlled by both terminals.

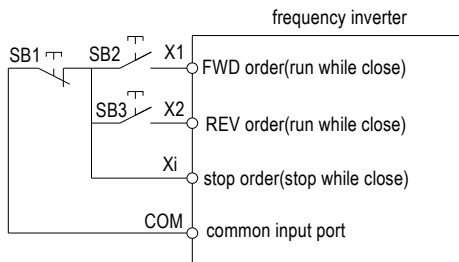

3: 3-line 2

**Note:** SB1: stop button. SB2: FWD button. SB3: REV button. Xi is set as 3 multi function input terminal 3 line control (Xi)].

F2.13	Terminal act mode	Setting range: 0000-0111	Factory set: 0111
-------	-------------------	--------------------------	-------------------

Only valid while [F0.02] is 1 and [F2.12] is set as 0 or 1.

**LED "0" digit: free stop terminal reset mode**

0: Reset to original order while invalid

1: Not reset to original order while invalid

**LED "00" digit: emergency stop terminal reset mode**

0: Reset to original order while invalid

1: Not reset to original order while invalid

**LED "000" digit: terminal run mode after fault reset**

0: Terminal control to power on directly

1: Terminal control to power on after stop

**LED "0000" digit: reserved**

**Note:** 3 channels all can send reset signal to inverter while fault alarm. If it is terminal control mode, inverter can select whether carry out terminal order by these parameters while receiving reset signal of terminal or the other two channels.

F2.14	X1-X4 input valid delay	Setting range: 0.00-60.00s	Factory set: 0.00s
F2.15	X5-X7 input valid delay	Setting range: 0.00-60.00s	Factory set: 0.00s

**X1-X4 input valid delay:** the parameter is defined as the time from giving X1-X4 input terminal valid electrical level to the time when inverter receives input signal.

**X5-X7 input valid delay:** same as X1-X4 input valid delay.

F2.16	PUL input min frequency	Setting range: 0.00-50.00kHz	Factory set: 0.00kHz
F2.17	PUL min frequency corresponding setting	Setting range: 0.00-100.00%	Factory set: 0.00%
F2.18	PUL input max frequency	Setting range: 0.00-50.00kHz	Factory set: 50.00kHz
F2.19	PUL max frequency corresponding setting	Setting range: 0.00-100.00%	Factory set: 100.00%

F2.20	PUL filter time	Setting range: 0.00-10.00s	Factory set: 0.10s
F2.21	PUL end frequency	Setting range: 0.000-1.000kHz	Factory set: 0.010kHz

**PUL input min frequency:** It defines the smallest frequency that pulse input terminal (PUL) can accept. If smaller than this value, inverter will deal as min frequency.

**PUL min frequency corresponding setting:** It defines the ratio of setting value corresponding to PUL min input frequency.

**PUL input max frequency:** It defines the max frequency that pulse input terminal (PUL) can accept. If bigger than this value, inverter will deal as max frequency.

**PUL max frequency corresponding setting:** It defines the ratio of setting value corresponding to PUL max input frequency.

**PUL filter time:** It is pulse signal filter time to eliminate disturb signal. The longer filter time is, the stronger anti-disturb force is. The shorter filter time is, the weaker anti-disturb force is. But respond speed will be quicker.

**PUL end frequency:** It is defined as smallest pulse frequency can be identified by PUL. Pulse frequency smaller than this value can not be identified. It will be deal as 0Hz. The smaller this value is, the smaller the pulse frequency identified by PUL is. When PUL frequency is disappear, the time of 0Hz pulse frequency judged by inverter is longer.

**Note: F2.06 must be 0, when using PUL input.**

F2.22	UP/DW terminal frequency adjust selection	Setting range: 0-2	Factory set: 0
F2.23	UP/DW terminal frequency add/reduce speed	Setting range: 0.01-50.00Hz/s	Factory set: 0.50Hz/s

#### UP/DW terminal frequency adjust selection

**0: Power down save** While UP/DW adjustment, it saves frequency records after power down or stop. Inverter continues last UP/DW adjustment while power on.

**1: Power down not save, stop save** While UP/DW adjustment, it saves frequency records after stop. Inverter continues last UP/DW adjustment while power on. It does not save frequency record after power down. Inverter runs from 0.00Hz.

**2: Valid in running, clear zero at stop** While UP/DW adjustment, it does not save frequency records after power down or stop. Inverter continues last UP/DW adjustment while power on. Inverter UP/DW adjusts from 0.00Hz next time.

**UP/DW terminal frequency increase/reduce speed:** While UP/DW adjustment, it modifies change rate of give frequency.

F2.24	Reserved
-------	----------

F2.25	Time unit for timer	Setting range: 0-2	Factory set: 0
F2.26	Timer setting	Setting range: 0-65000	Factory set: 0

**Time unit for timer**

0: Second

1: Minute

2: Hour

**Timer setting:** It is used for set timing of inverter. Timer start is finished by out timer touch terminal (select by [F2.00-F2.07]). Time begins while receiving signal. While time arriving, corresponding output terminal (selected by [F2.29-F2.31]) outputs 1s wide pulse signal. If out touch signal always at touching state, corresponding output terminal output one pulse signal every [F2.26] setting time. While touch terminal is invalid, timer keeps records and continues while touch terminal is valid again. Timer clear terminal can clear timer records anytime.

F2.27	Max value of counter	Setting range: 0-65000	Factory set: 1000
F2.28	Setting value of counter	Setting range: 0-65000	Factory set: 500

This parameter stipulates the counting action of the interior counter, clock terminal of the counter is selected by the parameter [F2.00-F2.06].

**Max value of counter:** When the counter to the reach the count value of exterior clock reach [F2.27] the value of stipulation, in the corresponding output terminal(selected by [F2.29-2.31]) output a width to be equal to exterior clock periodic valid signal.

**Setting value of counter:** When the counter to the reach the count value of exterior clock reach [F2.28] the value of stipulation, in the corresponding output terminal(selected by [F2.29-2.31]) output valid signal、 course the counter clear zero, abolishes this output valid signal.

Counter can be clear zero anytime by multifunction terminal [F2.00-2.06].

The clock periodic requirement of the counter is greater than 10ms; the minimum pulse width is 5ms.

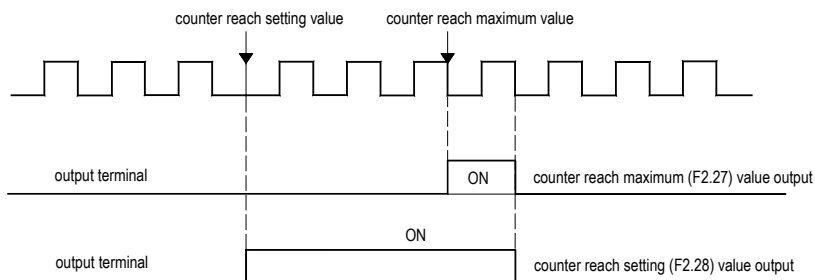

F2.29	Output terminal 1(Y)	Setting range: 0-47	Factory set: 1
F2.30	Relay output terminal 1(TA1-TB1-TC1)		Factory set: 2
F2.31	Relay output terminal2(TA2-TB2-TC3)		Factory set: 3

0: No output

1: Running

2: REV

3:FWD

4: Fault trip alarm 1(alarm while fault self-recover)

**5: Fault trip alarm 2(no alarm while fault self-recover)**

**6: Out fault stop**

**7: Under voltage** The frequency converter displays "E.LU1/2" for the voltage is excessively low, output signal.

**8: Finish ready for running**

**9: Output frequency level test 1(FDT1)**

**10: Output frequency level test 2(FDT2)** When the output frequency of frequency converter is over test level [F2.39]/[F2.41] setting, it outputs valid signal after [F2.40]/[F2.42] delay frequency. When output frequency is lower than test level, it outputs invalid signal after delay frequency. Details see [F2.39-F2.42].

**11: Frequency arrive** Details see [F2.43].

**12: Run as 0 speed**

**13: Upper frequency limit arrive**

**14: Lowest frequency limit arrive**

**15: Program running cycle finished** One cycle finished, it output 500ms signal.

**16: Program running step finished**

**17:PID feedback over upper limit** While PID feedback arrive [Fb.16] and still over limit after [Fb.14] delay time, it output valid signal.

**18:PID feedback under lowest limit** While PID feedback arrive [Fb.17] and still over limit after [Fb.14] delay time, it output valid signal.

**19: PID feedback sensor wire break** Details see [Fb.14-Fb.17].

**20: Reserved**

**21: Timer time arrive** Details see [F2.25-F2.26].

**22: Counter arrive biggest value** Details see [F2.27-F2.28].

**23: Counter arrive setting** Details see [F2.27-F2.28].

**24: Energy braking** Details see [FA.07].

**25: PG feedback break** Details see [F5.20-F5.25].

**26: Emergency stop**

**27: Pre alarm output for over load** It output valid signal while output current arrive or over [F2.44] and after [F2.45] delay time.

**28: Pre alarm output for under load** It output valid signal while output current is smaller or equal to [F2.46] and after [F2.47] delay time.

**Note:** Relay output terminal TA1-TC1 on and TB1-TC1 off is valid signal. Relay output terminal TA2-TC2 on and TB2-TC2 off is valid signal.Y output terminal with low level is combined to (+24V) terminal to output valid signal 24V power.

F2.32	Y and relay output feature	Setting range: 0000-1111	Factory set: 0000
-------	----------------------------	--------------------------	-------------------

**Y and relay output feature:** set multi-function output Y terminal, relay 1, relay 2 output feature.

**LED "0" digit: Y terminal output**

0: low electric level valid

1: high electric level valid

**LED "00" digit: relay 1 output**

0: positive logic

1: negative logic

**LED "000" digit: relay 2 output**

0: positive logic

1: negative logic

**LED "0000" digit: reserved**

F2.33	Y output start delay	Setting range:0.00-60.00s	Factory set: 0.00s
F2.34	Y output stop delay	Setting range:0.00~60.00s	Factory set: 0.00s

**Y output ON delay:** When the internal logic of the inverter operation opens Y terminal after a set extension time.

**Y output OFF delay:** When the internal logic of the inverter operation closes Y terminal after a set extension time.

F2.35	Relay 1 output start delay	Setting range:0.00-60.00s	Factory set: 0.00s
F2.36	Relay 1 output stop delay	Setting range:0.00-60.00s	Factory set: 0.00s
F2.37	Relay 2 output start delay	Setting range:0.00-60.00s	Factory set: 0.00s
F2.38	Relay 2 output stop delay	Setting range:0.00-60.00s	Factory set: 0.00s

**Relay 1 output start delay:** When the internal logic of the inverter operation opens relay1 after a set extension time.

**Relay 1 output stop delay:** When the internal logic of the inverter operation closes relay1 after a set extension time.

**Relay 2 output start delay:** When the internal logic of the inverter operation opens relay2 after a set extension time.

**Relay 2 output stop delay:** When the internal logic of the inverter operation closes relay2 after a set extension time.

F2.39	Output frequency level 1(FDT1)	Setting range:0.00-300.00Hz	Factory set: 30.00Hz
F2.40	FDT1 lag	Setting range:0.00-300.00Hz	Factory set: 0.00Hz
F2.41	Output frequency level 1(FDT2)	Setting range:0.00-300.00Hz	Factory set: 50.00Hz
F2.42	FDT2 lag	Setting range:0.00-300.00Hz	Factory set: 0.00Hz

Used to set test level. While output arrives or higher than [F2.39]/[F2.41] setting, FDT 1/2 terminal outputs signal after [F2.40]/[F2.42] delay frequency. While output arrives or lower than [F2.39]/[F2.41] setting, FDT 1/2 terminal stops output signal after [F2.40]/[F2.42] delay frequency.

F2.43	Given frequency reach detection magnitude	Setting range:0.00-50.00Hz	Factory set: 0.00Hz
-------	---	----------------------------	---------------------

While output frequency arrive or approach give frequency, output terminal Y/TA1-TB1-TC1/TA2-TB2-TC2 output valid signal if it is selected as "give frequency arriving". This function can used to adjust test range offset.

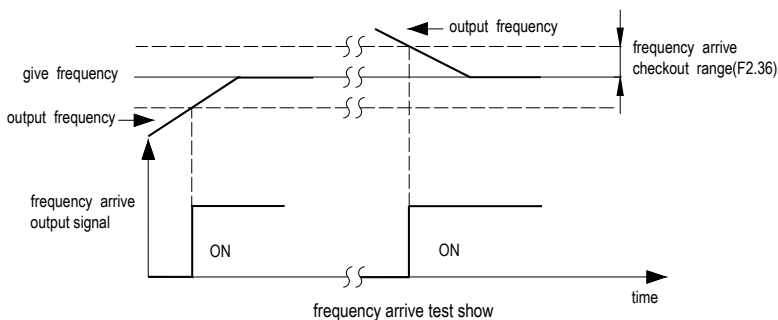

F2.44	Overload pre alarm level	Setting range:0.0-200.0%	Factory set: 180.0%
F2.45	Overload pre alarm delay	Setting range:0.0-100.0s	Factory set: 0.5s

While output current is over [F2.44] setting continuously, the output terminal outputs valid signal after [F2.45] delay frequency. While output current is lower than [F2.44] setting, the output terminal outputs invalid signal after [F2.45] delay frequency.

F2.46	Under load pre alarm level	Setting range:0.0-200.0%	Factory set: 30.0%
F2.47	Under load pre alarm delay	Setting range:0.0-100.0s	Factory set: 0.5s

While output current is equal to or lower than [F2.46] setting, the output terminal outputs valid signal after [F2.47] delay frequency. While output current is higher than [F2.46] setting, the output terminal outputs invalid signal after [F2.47] delay frequency. 100.00% corresponding to motor rated current.

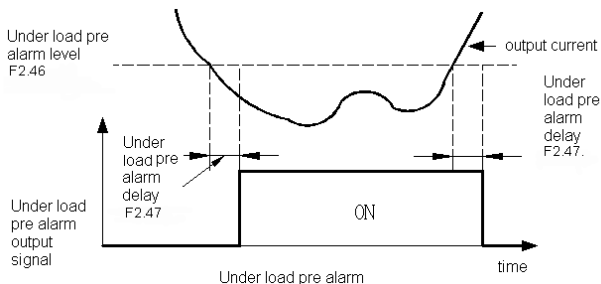

F2.48	Output frequency level 3	Setting range:0.00-10.00Hz	Factory set: 2.00Hz
F2.49	Output frequency level 4	Setting range:0.00-10.00Hz	Factory set: 6.00Hz

See parameter [F2.29-F2.31] Function 29: Output Frequency level detection 3.

**Expansion Card Terminal Description: input terminals X1-X7 reference description, please refer output terminal characteristic Y output terminal instructions.**



F2.60	X8-X10 extended terminal feature selection	LED "0" digit: X8 terminal 0: input 1: output LED "00" digit: X9 terminal 0: input 1: output LED "000" digit: X10 terminal 0: input 1: output LED "0000" digit: combination function selection 0: invalid 1: X8, X9 as the pins of CAN	Factory set: 0000
F2.61	X11-X13 extended terminal feature selection	LED "0" digit: X11 terminal 0: input 1: output LED "00" digit: X12 terminal 0: input 1: output LED "000" digit: X13 terminal 0: input 1: output LED "0000" digit: combination function selection 0: invalid 1: X11, X12, X13 as the pins of QEP (PG2_A, PG2_B, PG2_Z) 2: X10, X11, X12, X13 SPI	Factory set: 0000
F2.62	X8-X10 extended terminal feature selection	LED "0" digit: X8 terminal 0: on valid 1: off valid LED "00" digit: X9 terminal 0: on valid 1: off valid LED "000" digit: X10 terminal 0: on valid 1: off valid LED "0000" digit: reserved	Factory set: 0000
F2.63	X11-X13 extended terminal feature selection	LED "0" digit: X11 terminal 0: on valid 1: off valid LED "00" digit: X12 terminal 0: on valid 1: off valid LED "000" digit: X13 terminal	Factory set: 0000

		0: on valid 1: off valid LED "0000" digit: reserved	
F2.64	Multi-function terminal (X8)	Input function selection: Setting range and definition are the same as F2.00  Output function selection: Setting range and definition are the same as F2.29	Factory set: 0
F2.65	Multi-function terminal (X9)		Factory set: 0
F2.66	Multi-function terminal (X10)		Factory set: 0
F2.67	Multi-function terminal (X11)		Factory set: 0
F2.68	Multi-function terminal (X12)		Factory set: 0
F2.69	Multi-function terminal (X13)		Factory set: 0
F2.70	Extended terminal filter time	0.000-60.000s	Factory set: 0.010s
F2.71	Extended Y output start delay	0.00-60.00s	Factory set: 0.00s
F2.72	Extended Y output stop delay	0.00-60.00s	Factory set: 0.00s

**Note:**

- 1, when setting LED "0000" digit [F2.60] or LED "0000" digit [F2.61] as the extension pin, the expanded terminals can't be used as the input and output terminals; when set as invalid, it can be used as input and output terminal function.
- 2, extended Y output terminal characteristic can be selected by changes of [F2.62] and [F2.63].
- 3, when used as expanding PG speed detection or counting, LED "0000" digit [F2.61] should be set to 1.

## 9.4 Analog terminal functions

F3.00	VS Lowest limit	Setting range: 0.00-10.00V	Factory set: 0.00V
F3.01	VS Lowest limit corresponding setting	Setting range: 0.00-100.00%	Factory set: 0.00%
F3.02	VS upper limit	Setting range: 0.00-10.00V	Factory set: 10.00V
F3.03	VS upper limit corresponding setting	Setting range: 0.00-100.00%	Factory set: 100.00%
F3.04	VS filter time	Setting range: 0.00-10.00s	Factory set: 0.10s
F3.05	VS zero point loop voltage	Setting range: 0.00~10.00V	Factory set: 0.00V

**VS Lowest limit:** It defines signal accepted by analog input terminal (**VS**). Inverter deal voltage lower than this value as lower limit.

**VS lower limit corresponding setting:** It defines ratio of VS lower limit.

**VS upper limit:** It defines signal accepted by analog input terminal (**VS**). Inverter deal voltage higher than this value as higher limit.

**VS upper limit corresponding setting:** It defines ratio of VS upper limit.

**VS filter time:** It is (**VS**) input analog signal filter time to eliminate disturb signal. The longer filter time is, the stronger anti-disturb force is. The shorter filter time is, the weaker anti-disturb force is. But respond speed will be quicker.

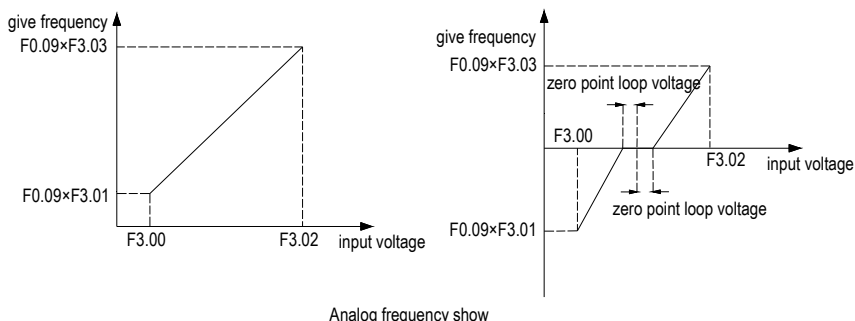

**VS zero point hysteresis voltage:** the deviation between input voltage and zero voltage is within hysteresis voltage [F3.05]; VS output is 0

F3.06	AI used as VS lower limit	Setting range: 0.00-10.00V	Factory set: 0.10V
F3.07	AI lower limit corresponding setting	Setting range: 0.00-100.00%	Factory set: 0.00%
F3.08	AI used as VS upper limit	Setting range: 0.00-10.00V	Factory set: 9.90V
F3.09	AI upper limit corresponding setting	Setting range: 0.00-100.00%	Factory set: 100.00%
F3.10	AI filter time	Setting range: 0.00-10.00s	Factory set: 0.10s
F3.11	AI used as AS lower limit	Setting range: 0.00-20.00mA	Factory set: 4.00mA
F3.12	AI used as AS upper limit	Setting range: 0.00-20.00mA	Factory set: 20.00mA
F3.13	AS lower limit	Setting range: 0.00-20.00mA	Factory set: 4.00mA
F3.14	AS lower limit corresponding setting	Setting range: 0.00-100.00%	Factory set: 0.00%
F3.15	AS upper limit	Setting range: 0.00-20.00mA	Factory set: 20.00mA
F3.16	AS upper limit corresponding setting	Setting range: 0.00-100.00%	Factory set: 100.00%
F3.17	AS filter time	Setting range: 0.00-10.00s	Factory set: 0.10s

See VS specification.

**Note:** Please select K4, when AI is used as analog voltage input; Please select K3, when AI is used as analog current input. All is analog voltage input in factory default hardware setting.

F3.18-F3.21	Reserved
-------------	----------

F3.22	A01 output selections	Setting range: 0-17	Factory set: 0
F3.23	A02 output selections		Factory set: 1

Used for setting inverter monitor corresponding to multifunction terminal (AO1),(AO2) output signal.

(AO1) output signal is decided by [F3.24]

(AO2) output signal is decided by [F3.27]

Setting	monitor	Function	AO min output	AO max output
0	Give frequency	Corresponding to current give frequency	Min output corresponding to 0.00Hz	Max output corresponding to max frequency
1	Output frequency	Corresponding to current output frequency	Min output corresponding to 0.00Hz	Max output corresponding to max frequency
2	Output current	Corresponding to current output current	Min output corresponding to 0.00A	Max output corresponding to 2 times of rated current
3	Input voltage	Corresponding to current input voltage	Min output corresponding to 0V	Max output corresponding to 2 times of rated voltage
4	Output voltage	Corresponding to current output voltage	Min output corresponding to	Max output corresponding to 2 times of rated voltage
5	Machine speed	Corresponding to current machine speed	Min output corresponding to 0 speed	Max output corresponding to speed corresponding to max frequency
6	Reserved	Reserved	Reserved	Reserved
7	Reserved	Reserved	Reserved	Reserved
8	PID give	Corresponding to current PID give	Min output corresponding to 0.00% PID give	Max output corresponding to 200% PID give
9	PID feedback	Corresponding to current PID feedback	Min output corresponding to 0.00% PID feedback	Max output corresponding to 100% PID feedback
10	Output power	Corresponding to current output power	Min output corresponding to 0 power	Max output corresponding to rated output power
11	Bus voltage	Corresponding to current input voltage	Min output corresponding to 0V	Max output corresponding to 2 times rated DC voltage2
12	VS input	Corresponding to current VS input	Min output corresponding to VS input lowest limit	Max output corresponding to VS input upper limit
13	AI input	Corresponding to current AI input	Min output corresponding to AI input lowest limit	Max output corresponding to AI input upper limit
14	AS input	Corresponding to current AS input	Min output corresponding to AS input lowest limit	Max output corresponding to AS input upper limit
15	PUL input	Corresponding to current PUL input	Min output corresponding to PUL input lowest limit	Max output corresponding to PUL input upper limit
16	Module temperature 1	Corresponding to current module temperature 1	Min output corresponding to 0 degree module temperature 1	Max output corresponding to module temperature 1 is 100 degree
17	Module temperature 2	Corresponding to current module temperature 2	Min output corresponding to 0 degree module temperature 2	Max output corresponding to module temperature 2 is 100 degree

F3.24	A01 signal selection	Setting range: 0-2	Factory set: 0
F3.25	A01 output gain	Setting range: 25.0-200.0%	Factory set: 100.0%
F3.26	A01 output signal bias	Setting range: -100.0-100.0%	Factory set: 0.0%

**A01 signal selection:**

0: 0-10V

- 1: 4.00-20.00mA
- 2: 0.00-20.00mA

**Note:** After output mode is selected by parameter. K1, K2 ON/OFF mode need to select according the following ways:

1. If 0-10V output, K2 ON.
2. If 0.00-20.00mA or 4.00-20.00mA output, K1 ON.

Factory setting is 0-10V output for both hardware and software. If need change, please change both hardware and software.

**AO1 output gain:** It is used to adjust AO1 terminal output analog.

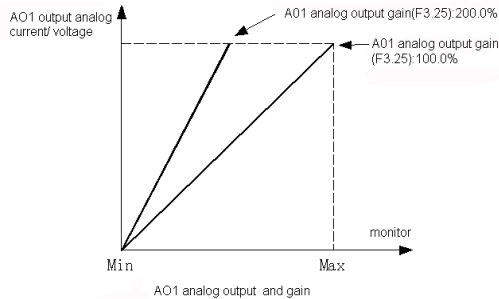

**AO1 output signal bias:** It is used to adjust AO1 terminal 0 point of output signal.

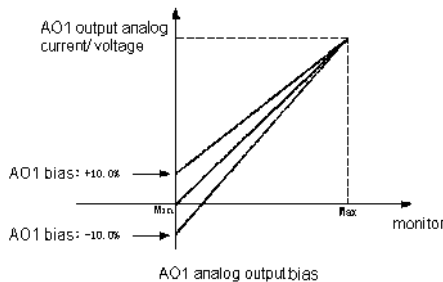





F3.27	AO2 signal selection	Setting range: 0-4	Factory set: 0
-------	----------------------	--------------------	----------------

- 0: 0-10V
- 1: 4.00-20.00mA
- 2: 0.00-20.00mA
- 3: FM Frequency pulse output output lowest limit is decided by [F3.30], upper limit is set by [F3.31].

**Note:** After output mode is selected by parameter. J1, J2, J3 ON/OFF mode need to select according the following ways:

1. If pulse output, J1 ON.
2. If 0.00-20.00mA or 4.00-20.00mA output, J2 ON.
3. If 0-10V output, J3 ON.

Factory setting is 0-10V output for both hardware and software. If need change, please change both hardware and software.

Switch terminal	Selection position	cutline	function
	J1		0.0-50kHz frequency output
	J2		0-20mA current output 4-20mA current output
	J3		0-10V voltage output

F3.28	A02 output gain	Setting range: 25.0-200.0%	Factory set: 100.0%
F3.29	A02 output signal bias	Setting range: -100.0-100.0%	Factory set: 0.0%

See A01 parameters.

F3.30	A02FM frequency output Lowest limit	Setting range: 0.00-50.00kHz	Factory default :0.20kHz
F3.31	A02FM frequency output upper limit	Setting range: 0.00-100.00kHz	Factory default:50.00kHz

While A02 is set as FM frequency pulse output, it is lower limit and upper limit of the signal.

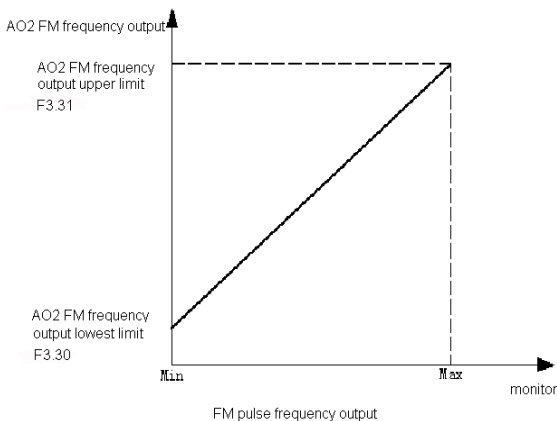

F3.32	A02 Fixed frequency width setting frequency	Setting range: 0.20-4.00kHz	Factory default:0.50kHz
F3.33	A02 Fixed frequency width setting duty cycle	Setting range: 0.0-100.0%	Factory default: 0.0%

**A02 Fixed frequency width setting frequency:** set the PWM wave frequency when A02 Fixed frequency width setting frequency outputs.

**A02 Fixed frequency width setting duty cycle:** set the PWM wave A02 Fixed frequency width setting duty cycle.

## 9.5 Keyboard and display parameters

F4.00	Parameter and key lock selections	Setting range: 0-3	Factory set: 0
-------	-----------------------------------	--------------------	----------------

**0: Unlock** Parameter and keyboard lock function invalid.

**1: Parameter lock** Lock all function parameter settings, can not modify (except the F0.08). Can not enter into the parameter setting. All buttons in the keypad are unlocked.

**2: Parameter and key lock (except FWD/STOP/JOG)** Lock all parameter settings, can not modify. And lock all keys on keyboard except FWD/STOP/JOG.

**3: All parameter and key lock** Lock all parameter settings, can not modify. And lock all keys on keyboard except PRG.

**Note:**

**1. 2 lines keypad unlock method:** Press "PRG" and 1<sup>st</sup> line show "CodE". And use the "UP"- "DOWN" key to move to 2<sup>nd</sup> line, then enter password (F4.01-user password) and press "SET".

**2. Single line keypad unlock method:** Press "PRG" and show "CodE". Press "SET" then enter password (F4.01-user password) and press "SET" again and will be clear!

**3. User password is a parameter which purpose is to protect the inverter from tampering at will. In order to avoid bring inconvenience, please keep it confidential!**

F4.01	User password	Setting range: 0-9999	Factory set: 0
-------	---------------	-----------------------	----------------

It used to set user password. While [F4.00] is (not 0) lock state, need input this password to unlock. Factory set is 0.

F4.02	REV/JOG selections	Setting range: 0-1	Factory set: 0
-------	--------------------	--------------------	----------------

**0: REV** While keyboard control, press this button, inverter reverse run. Key REV/JOG not light.

**1: JOG** While keyboard control, press this button, inverter JOG. Key REV/JOG light.

F4.03	STOP key function range	Setting range: 0000-0011	Factory set: 0100
-------	-------------------------	--------------------------	-------------------

**LED "0" digit: terminal control**

**0: invalid to terminal order** While terminal given signal, STOP key can not control to stop.

**1: valid to terminal order** While terminal given signal, STOP key can control to stop.

**LED "00" digit: communication control**

**0: invalid to communication order** While terminal given signal, STOP key can not control to stop.

**1: valid to communication order** While terminal given signal, STOP key can control to stop.

**LED "000" digit: reserved**

**LED "0000" digit: reserved**

**Note:** While valid to terminal order or communication order, inverter is in stop lock state after press STOP key. If inverter needs to restart, stop order needs to be given by selected order channel to unlock stop state firstly.

F4.04	UP/DOWN key modification selections	Setting range: 0000-0014	Factory set: 0011
-------	-------------------------------------	--------------------------	-------------------

**LED "0" digit: keyboard UN/DOWN key modify selection**

**0: Invalid** UP/DOWN key can not modify parameters.

**1: Modify frequency setting by key board numbers (F0.08)** UP/DOWN key can modify parameters [F0.08].

2: Reserved

3: **Modify PID give setting by key board numbers (Fb.01)** UP/DOWN key can modify parameters [Fb.01].

4: Reserved

LED "00" digit: keyboard UN/DOWN key store selection

0: No save after power down

1: Save after power down

It is used to select whether save the parameter modified by UP/DOWN key while power cut.

LED "000" digit: reserved

LED "0000" digit: reserved

F4.05	Function parameter copy	Setting range: 0-2	Factory set: 0
-------	-------------------------	--------------------	----------------

0: No operation

1: Send machine parameters to keyboard and save

2: Send parameters saved by keyboard to machine

**Note:**

1. **Keyboard will not send stored parameters to inverter when inverter is running or in fault state or no data stored in keyboard.**

2. **When sending data to keyboard, if keyboard is out of inverter, it will not finish copy operation, and needs to retry it.**

3. **When sending data to inverter, if keyboard is out of inverter, it will not finish download operation and needs to retry it.**

4. **When sending data to keyboard, current state of inverter will not be remain. And all keys are invalid when sending data to inverter.**

5. **If it displays E.CEP, operation of copy parameter will be interrupted and needing to retry it. Press STOP button to return monitor menu.**

6. **When software is not compatible, it shows E.ED1, and will not send data to inverter.**

F4.06	Reserved		
-------	----------	--	--

F4.07	Keyboard potentiometer lowest limit	Setting range: 0.00-5.00V	Factory set: 0.50V
F4.08	Keyboard potentiometer lowest limit corresponding setting	Setting range: 0.00-100.00%	Factory set: 0.00%
F4.09	Keyboard potentiometer upper limit	Setting range: 0.00-5.00V	Factory set: 4.50V
F4.10	Keyboard potentiometer upper limit corresponding setting	Setting range: 0.00-100.00%	Factory set: 100.00%

**Keyboard potentiometer lowest limit:** It defines the lower limit of the signal given by potentiometer. Inverter treat the voltage lower than this value as the lower limit signal.

**Keyboard potentiometer lowest limit corresponding setting:** It sets ratio of keyboard potentiometer lower limit.

**Keyboard potentiometer upper limit:** It defines the upper limit of the signal given by potentiometer. Inverter treat the voltage higher than this value as the lower limit signal.

**Keyboard potentiometer upper limit corresponding setting:** It sets ratio of keyboard potentiometer upper limit.



F4.11	Upper LED display content while run	Setting range: 0000-FFFF	Factory set: 3210
F4.12	Upper LED display content while stop	Setting range: 0000-FFFF	Factory set: 3210

**Upper LED display content while run:** Set monitor content showed in the upper line of LED while running. The content can be modified by "SET" key while running. Not save modification while power cut. Default to display LED "0" digit setting after power on.

**Upper LED display content while stop:** Set monitor content showed in the upper line of LED while stop. The content can be modified by "SET" key while stop. Not save modification while power cut. Default to display LED "0" digit setting after power on.

#### LED "0" digit to "0000" digit setting

0: Given frequency      1: Output frequency      2: Output current      3: Input voltage  
 4: Output voltage      5: Machine speed      6: Reserved      7: Output torque  
 8: PID given value      9: PID feedback value      A: Output power      B: Bus voltage  
 C: Module temperature 1      D: Module temperature 2      E: ON/OFF state of input terminal X  
 F: ON/OFF state of input terminal Y

F4.13	Lower LED display content while run	Setting range: 0000-FFFF	Factory set: 3210
F4.14	Lowest LED display content while stop	Setting range: 0000-FFFF	Factory set: 3210

Only valid for keyboard with 2 line LED. Details refer to [F4.11-F4.12].

F4.15	Rotate speed display coefficient	Setting range: 0.1-5000.0%	Factory set: 100.0%
-------	----------------------------------	----------------------------	---------------------

It sets the display coefficient of keyboard monitor item "machine speed". 100% is corresponding to motor rated speed.

F4.16	Keyboard display selections	Setting range: 0000-1111	Factory set: 0000
-------	-----------------------------	--------------------------	-------------------

#### LED "0" digit: LCD display language

0: Chinese  
 1: English

#### LED"00" digit: output frequency selection

0: Aim frequency  
 1: Actual frequency

#### LED"000" digit: machine speed display selection

0: Actual speed  
 1: Aim speed

#### LED"0000" digit: reserved

## 9.6 Motor parameters

F5.00	Reserved		
-------	----------	--	--

F5.01	Motor rate	Setting range: 2-48	Factory set: 4
-------	------------	---------------------	----------------

Set it according to nameplate.

F5.02	Motor rated power	Setting range: 0.4-1000.0kW	Factory set: Accord model
-------	-------------------	-----------------------------	---------------------------

Set it according to nameplate based on unit of 0.1kw. While motor rated power setting is changed, inverter will automatic adjust [F5.03-F5.11] to default. If self-study, [F5.07-F5.11] will automatic change according to the result of self study. If need high accuracy control, It must self study after right [F5.01-F5.06] setting.

F5.03	Motor rated frequency	Setting range: 0.01Hz-max frequency	Factory set: Accord model
-------	-----------------------	-------------------------------------	---------------------------

Set it according to nameplate.

F5.04	Motor rated speed	Setting range: 0-65000rpm	Factory set: Accord model
-------	-------------------	---------------------------	---------------------------

Set it according to nameplate.

F5.05	Motor rated voltage	Setting range: 0-1500V	Factory set: Accord model
-------	---------------------	------------------------	---------------------------

Set it according to nameplate.

F5.06	Motor rated current	Setting range: 0.1-2000.0A	Factory set: Accord model
-------	---------------------	----------------------------	---------------------------

Set it according to nameplate.

F5.07	Motor no-load current	Setting range: 0.01-650.00A	Factory set: Accord model
-------	-----------------------	-----------------------------	---------------------------

It set automatic while self study.

F5.08	Motor stator resistance	Setting range: 0.001-65.000	Factory set: Accord model
-------	-------------------------	-----------------------------	---------------------------

It set automatic while self study.

F5.09	Motor rotor resistance	Setting range: 0.001-65.000	Factory set: Accord model
-------	------------------------	-----------------------------	---------------------------

It set automatic while self study.

F5.10	Motor stator&rotor inductance	Setting range: 0.1-6500.0mH	Factory set: Accord model
-------	-------------------------------	-----------------------------	---------------------------

It set automatic while self study.

F5.11	Motor stator&rotor mutual inductance	Setting range: 0.1-6500.0mH	Factory set: Accord model
-------	--------------------------------------	-----------------------------	---------------------------

It set automatic while self study.

F5.12	Parameters self-adjustment selections	Setting range: 0-2	Factory set: 0
-------	---------------------------------------	--------------------	----------------

**0: No operation** Set as default without self study.

**1: Rotary type self-study** Before self adjustment, [F5.01-F5.06] of asynchronous motor which is controlled must be set as right value. While self adjustment, firstly, asynchronous motor at static state, it automatic detects motor stator resistance, motor rotor resistance, motor stator&rotor inductance. Then the asynchronous motor at rotate state, it automatic detects motor no-load current, motor stator&rotor mutual inductance. All results will be auto written in [F5.08], [F5.09], [F5.10] and [F5.07], [F5.11] and renewed while adjustment is over. After parameter setting, press FWD key to start self study, keyboard LED display "t-01". Motor automatic stop while self adjustment is over. Inverter reback to standby state.

**2: Resting type self-study** Before self adjustment, [F5.01-F5.06] of motor which is controlled must be set as right value. While self adjustment, motor at static state, it automatic detects motor stator resistance, motor rotor resistance, motor stator&rotor inductance. All results will be auto written in [F5.08], [F5.09], [F5.10] and renewed while adjustment is over. After parameter setting, press FWD key to start self study, keyboard LED display "t-02". FWD indicator is off while self adjustment is over. Inverter reback to standby state.

**Note:** [F5.12] is automatic set as 0 after self adjustment.

**Attention:**

- Before setting [F5.12] as 1 –self study, unload the motor firstly.
- In some occasions (such as can not unload), if it can not self study or it is not high control accuracy required, static self study or no self study is ok. If no self study, please do set right parameters [F5.01-F5.06]
- If user know the right parameter. User can set [F5.01-F5.11] directly.
- Ensure stop state before starting self study, otherwise, self study can not be normal.
- While [F5.12] is 1, if there is over voltage or over current in self study process, ACC/DEC time [F0.14, F0.15] can be prolonged.
- If static self study is not successful, alarm E.tE1 fault. If rotary self study is not successful, alarm E.tE2 fault.

F5.13	Motor coefficient 1	Setting range: 0-2048	Factory set: According to model
F5.14	Motor coefficient 2	Setting range: 1-10000	Factory set: According to model
F5.15	Motor coefficient 3	Setting range: 1-10000	Factory set: According to model
F5.16	Motor coefficient 4	Setting range: 1-10000	Factory set: According to model

Motor correlation coefficient obtained after the motor study [F5.13-F5.16], the set of parameters would affect the effectiveness of the vector control

F5.17-F5.19	Reserved
-------------	----------

F5.20	PG selection	Setting range: 0000-1111	Factory set: 0001
F5.21	PG pulse per loop	Setting range: 1-60000	Factory set: 1024
F5.22	PG line-break inspection time	Setting range: 0.100-30.000s	Factory set: 2.000s

**PG selection:**

LED "0" digit::Input phase

**0: 1-phase input** Only feedback one of A and B and inspect motor speed. Not identify direction.

**1: 2-phase input** Feedback both A and B. Inspect both speed and direction.

**LED "00" digit: input phase adjustment**

While encoder A/B phase is converse, it can be adjusted by this parameter. No need to change the wire. Only valid while both phase are valid.

**0: same direction** Sensor phase is the same as motor phase, no need adjust.

**1: reverse direction** Sensor phase is reverse to motor phase, need adjust.

**LED "000" digit:**

**0: break inspection OFF** No line-break inspection.

**1: break inspection ON** While feedback signal of sensor disappears and after [F5.17] delay time, still no feedback signal is received. Inverter will alarm for PG line-break fault and stop output. Motor free stop.

**LED "0000" digit: reserved**

**Note: Under closed loop mode, while feedback signal is 2 phase input and PG card feedback direction is reverse to motor output direction. Inverter can't run normally. Please adjust [F5.15] LED "00" digit setting.**

**PG pulse per loop:** Set according sensor specification.

**PG line-cut inspection time:** Set delay time for ensure sensor line break while sensor line-break inspection is valid.

F5.23	Extended PG selection	Setting range: 0000-1111	Factory default: 0001
F5.24	Extended PG pulse per week	Setting range: 1-60000	Factory default: 1024
F5.25	Extended PG line-cut inspection time	Setting range: 0.100-30.000s	Factory default: 2.000s

Please see [F5.20-F5.22] parameters.

F5.26 - F5.27	Reserved
---------------	----------

F5.28	Speed measuring and counter selection	Setting range: 0000-1122	Factory default: 0020
F5.29	PG and extended PG counter clear lower position	Setting range: 0-65535	Factory default: 65535
F5.30	PG and extended PG counter clear upper position	Setting range: 0-65535	Factory default: 65535
F5.31	PUL counter frequency-dividing	Setting range: 0-31	Factory default: 0

Speed measuring and counter selection:

**LED "0" digit: hardware speed measuring channel selection**

When control mode is selected as VC with PG or V/F with PG, it should be selected based on the close-loop feedback.

0:PG

1:PUL port

2:extended PG

**LED "00" digit: counting selection**

0:PG

1:PUL port

2:extended PG

**LED "000" digit: counting direction**

0: FWD.

1: REV

#### LED "0000" digit: PG and extended PG counter zero clear

0: counter reaches the setting zero clear value (F5.29+F5.30×65536)

1: Z signal zero clear

**PG and PG extensions count value clear low position:** When [F5.28] LED "0000" digit is set as 1, [F5.29-F5.30] setting value is valid, the count value range is 0 ~ [F5.29] + [F5.30] × 65536; counter display see low 16 [C-33] and 16 high [C-34], the actual count value [C-33] + [C-34] × 65536.

**PG and PG extensions count clear value high position:** see [F5.29].

**PUL counter dividing:** when PUL port input signal frequency is higher, frequency dividing is needed for proper counting; the actual dividing value = [F5.31] × 2, pulse frequency after dividing should be less than 0.97 kHz to ensure correct counting.

#### Note:

1. When control mode is selected as VC with PG or V/F with PG and the LED "0" digit and LED "00" digit are all set as 0 or 2, the encoder direction would be changed if the counting direction of [F5.28] LED "000" digit is changed, at this time the input phase of PG and extended PG should be changed; usually set the REV counter first and adjust input phase of PG and extended PG based on the encoder direction.
2. When [F5.28] is set as 1, PG and extended PG should connect the Z signal of encoder.

## 9.7 VC control parameter

F6.00	ASR proportional gain 1	Setting range: 0.00-2.00	Factory set: Accord model
F6.01	ASR integral time 1	Setting range: 0.01-10.00s	Factory set: Accord model
F6.02	ASR differential coefficient time 1	Setting range: 0.0-100.0	Factory set: 0.0
F6.03	ASR filter time1	Setting range: 0.000-0.100s	Factory set: 0.020s
F6.04	ASR switch frequency 1	Setting range: 0.00-50.00Hz	Factory set: 5.00Hz
F6.05	ASR proportional gain 2	Setting range: 0.00-1.00	Factory set: Accord model
F6.06	ASR integral time 2	Setting range: 0.01-10.00s	Factory set: Accord model
F6.07	ASR differential coefficient time 2	Setting range: 0.0-100.0s	Factory set: 0.0s
F6.08	ASR filter time 2	Setting range: 0.000-0.100s	Factory set: 0.020s
F6.09	ASR switch frequency 2	Setting range: 0.00-50.00Hz	Factory set: 10.00Hz

[F6.00-F6.09] is only valid under VC control and PG V/F control. It changes speed response by set proportional gain P and integral time of speed adjustor.

**ASR proportional gain and ASR integral time adjustment:** System response will be quicker by increase proportional gain. But if proportional gain is too big, there is surge easily. System response will be quicker by decreasing integral time. But if integral time is too short, there is surge easily. Usually, adjust proportional gain firstly, then adjust integral time.

**Note:** If ASR proportional gain is too big and ASR integral time is too small, over voltage maybe caused while system start to high speed quickly (without extra braking resistance or braking unit). It is caused by erborn energy feedback and can be avoided by adjust ASR proportional gain bigger and ASR integral time smaller.

**ASR proportional gain and ASR integral time adjustment at high/low speed:** Set ASRswitch frequency [F6.04] and [F6.09] while it has quick response requirement for load at high/low speed.

Usually increase proportional gain and decrease integral time to improve response at low frequency running. Usually adjust as this: Set right [F6.04] and [F6.09]. The first group of ASR parameter is valid while output frequency is under switch frequency 1 [F6.04]. The second group of ASR parameter is valid while output frequency is between switch frequency 1 [F6.04] and switch frequency 2 [F6.09]. Parameter linearly transits from switch frequency 1 [F6.04] to switch frequency 2 [F6.09] pro rate. Adjust ASR proportional gain 1 [F6.00] and ASR integral time 1 [F6.01] at low speed to ensure no surge and good response. Adjust ASR proportional gain 2 [F6.05] and ASR integral time 2 [F6.06] at high speed to ensure no surge and good response.

Usually, ASR differential coefficient time is not need to set. It is used to restrain sudden speed change. If it is too big, surge comes easily.

F6.10	VC control slip coefficient	Setting range: 0-250%	Factory set: 100%
-------	-----------------------------	-----------------------	-------------------

Used in occasion need quick response and high speed accuracy. Adjust this parameter properly, the system response can be improved and stable speed error can be eliminated.

F6.11	Max output torque	Setting range: 20.0-250.0%	Factory set: 165.0%
-------	-------------------	----------------------------	---------------------

100.00% is corresponding to rated current.

F6.12	Constant power area torque compensation start frequency	Setting range: 100.0-500.0%	Factory set: 120.0%
F6.13	Constant power area torque compensation coefficient	Setting range: 0-100%	Factory set: 30%

**Constant power area torque compensation start frequency:** Set start frequency of torque compensation in constant power area under VC control. 100.00% is corresponding to motor rated frequency.

**Constant power area torque compensation coefficient:** Set coefficient of torque compensation in constant power area. The coefficient is bigger, the compensation is bigger. While this function is on, it effectively helps to improve load capability at motor weak magnetic area.

F6.14-F6.19	Reserved		
-------------	----------	--	--

F6.20	vector ACR proportional gain	Setting range: 0.01-5.00	Factory default: According to model
F6.21	vector ACR integral time	Setting range: 0.01-0.00	Factory default: According to model
F6.22	vector ACR filter coefficient	Setting range: 0.01-0.00	Factory default: According to model

Function code [F6.20-F6.22] is valid under vector control and VC with PG. Change the torque response characteristic of PG vector control and vector control modes by setting the vector ACR (current loop) proportional gain P and integral time I.

F6.23	Reserved		
-------	----------	--	--

## 9.8 V/F control parameters

F8.00	V/F curve selection	Setting range:0-4	Factory set: 0
-------	---------------------	-------------------	----------------

0 beeline can be selected for general used load. Falling torque curve can be for fan and pump.

0: Beeline

1: User-defined V/F curve Details refer to [F8.01-F8.10].

2: 1.3 power falling torque curve

3: 1.7 power falling torque curve

4: 2.0 power falling torque curve

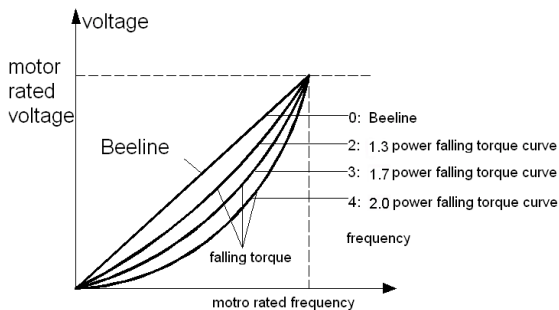

V/F curve

F8.01	Self-setting voltage V1	Setting range: 0.0-100.0%	Factory set: 3.0%
F8.02	Self-setting frequency F1	Setting range: 0.00-max frequency	Factory set: 1.00Hz
F8.03	Self-setting voltage V2	Setting range: 0.0-100.0%	Factory set: 28.0%
F8.04	Self-setting frequency F2	Setting range: 0.00-max frequency	Factory set: 10.00Hz
F8.05	Self-setting voltage V3	Setting range: 0.0-100.0%	Factory set: 55.0%
F8.06	Self-setting frequency F3	Setting range: 0.00-max frequency	Factory set: 25.00Hz
F8.07	Self-setting voltage V4	Setting range: 0.0-100.0%	Factory set: 78.0%
F8.08	Self-setting frequency F4	Setting range: 0.00-max frequency	Factory set: 37.50Hz
F8.09	Self-setting voltage V5	Setting range: 0.0-100.0%	Factory set: 100.0%
F8.10	Self-setting frequency F5	Setting range: 0.00-max frequency	Factory set: 50.00Hz

**Self-setting V/F curve:** User sets the 1<sup>st</sup>/2<sup>nd</sup>/3<sup>rd</sup>/4<sup>th</sup>/5<sup>th</sup> voltage ratio of V/F curve corresponding to F1/F2/F3/F4/F5 frequency based on rated output voltage 100%. User sets the 1<sup>st</sup>/2<sup>nd</sup>/3<sup>rd</sup>/4<sup>th</sup>/5<sup>th</sup> frequency of V/F curve corresponding to V1/V2/V3/V4/V5.

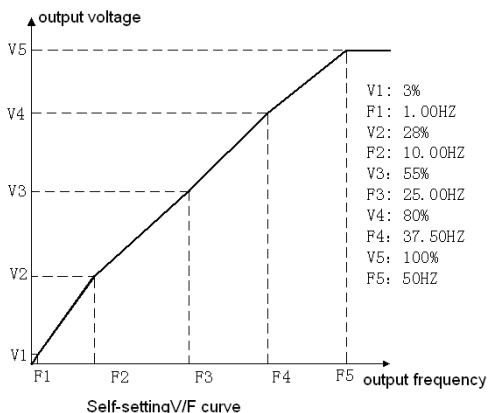

Must meet:  $0 \leq F1 \leq F2 \leq F3 \leq F4 \leq F5 \leq \text{max frequency}$ ,  $0 \leq V1 \leq V2 \leq V3 \leq V4 \leq V5 \leq 100.0\%$

V1, V2, V3, V4, V5 is based on motor rated voltage.

F8.11	Output voltage percentage	Setting range: 25.0-120.0%	Factory set: 100.0%
-------	---------------------------	----------------------------	---------------------

Output voltage adjustment coefficient adjusts output voltage of inverter to meet different V/F requirement.

F8.12	Torque improve	Setting range: 0.1-30.0%	Factory set: Accord model
F8.13	Torque improve close frequency	Setting range: 0.0-100.0%	Factory set: 5.0%

**Torque improve:** Improve low frequency torque trait by voltage compensation. Please set it rightly. If too high, motor maybe happens over excitation at low frequency running, over heat while long time, even over current protection or can not start normally.

**Note:** while [F8.00] is 1, [F8.12] is invalid.

**Torque improve close frequency:** Set torque improve valid range. While output frequency is over this value, torque improving function stops. 100% is corresponding to motor rated frequency.

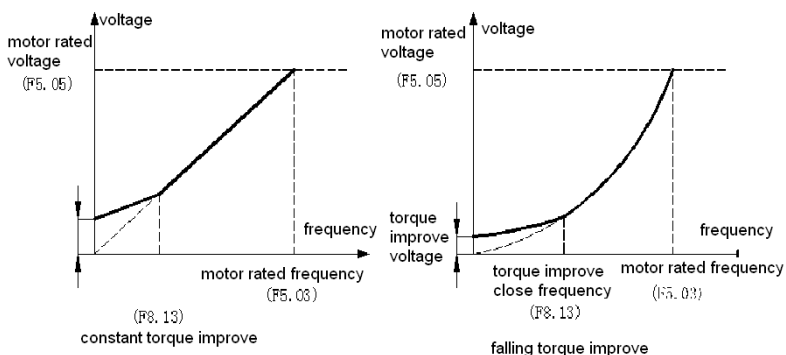



F8.14	V/F slip compensation	Setting range:0.0-200.0%	Factory set:0.0%
-------	-----------------------	--------------------------	------------------

It makes inverter output frequency self adjust within a setting range according motor load change to compensate slip frequency to make motor keep constant speed. It effectively relieves the impact of load change to motor speed.

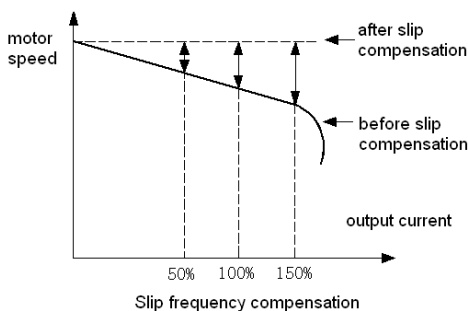

If compensation setting is too big, it maybe causes motor speed over settings.

F8.15	Auto energy save selection	Setting range: 0-1	Factory set: 0
F8.16	Lowest frequency limit of energy save running	Setting range: 0.0-500.0%	Factory set: 20.0%
F8.17	Energy save voltage down time	Setting range: 0.01-50.00s	Factory set: 10.00s
F8.18	Energy save voltage lowest limit	Setting range: 20.0-100.0%	Factory set: 50.0%
F8.19	Voltage fall recovery time	Setting range: 0.01~50.00s	Factory default:According to model

#### Auto energy save selection:

0: no auto energy save

1: auto energy save

**Lower frequency limit of energy save running:** When output frequency is lower than this value, auto energy save function will close. 100% is corresponding to motor rated frequency.

**Energy save voltage fall time:** It is the time output voltage from rated voltage to 0V while meet auto energy save conditions.

**Energy save voltage lowest limit:** Set lowest limitation of voltage while energy save running. 100% is corresponding to motor rated frequency.

**Voltage fall recovery time:** the time needed for output voltage rising from 0 to motor rated voltage when auto energy saving running requirement satisfied.

F8.20	ASR(VF) proportion gain 1	Setting range:0.00-50.00	Factory set: 1.00
F8.21	ASR(VF) integral time 1	Setting range:0.000-1.000s	Factory set: 0.010s

F8.22	ASR(VF) filter time1	Setting range:0.000-1.000s	Factory set: 0.010s
F8.23	ASR(VF) switch frequency 1	Setting range:0.00-50.00Hz	Factory set: 5.00Hz
F8.24	ASR(VF) proportion gain 2	Setting range:0.0-50.00	Factory set: 0.10
F8.25	ASR(VF) integral time 2	Setting range:0.000-1.000s	Factory set: 0.020s
F8.26	ASR(VF) filter time 2	Setting range:0.000-1.000s	Factory set: 0.010s
F8.27	ASR(VF) switch frequency 2	Setting range:0.00-50.00Hz	Factory set: 10.00Hz

[F8.20-F8.27] is valid under V/F with PG mode. It changes the speed response features by setting proportion gain P and integral time I of the speed adjuster.

**ASR (VF) proportion gain:** Make inverter respond quicker to load by adjust proportion gain bigger. But it is easy to cause vibration while proportion gain is too big. Make inverter respond slower to load by adjust proportion gain smaller. It is easy to reduce vibration while proportion gain is small.

**ASR (VF) integral time:** Respond to sudden changed load will be slower while integral time is long. But it is valid to reduce vibration. General speaking, the proportion gain is adjusted firstly (as big as possible based on no system vibration). Then adjust integral time to make system has quick respond without vibration.

**ASR (VF) filter time:** It is easy to be disturbed while PG card sampling. So it needs to filter.

**ASR proportion gain, integral time adjustment at high/low speed:** If system needs quick respond both at high and low speed, it can set ASR(VF)switch frequency [F8.23] and [F8.27]

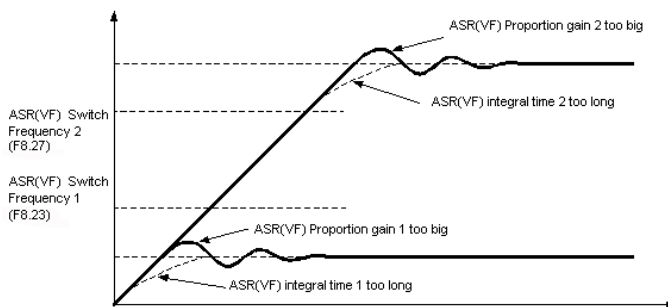

Relationship between Proportion gain and Integral time under PG/VF control

**Note:** If proportion gain is too big and integral time is too short, the system may meet voltage fault after start to high speed at short time (no optional resistance and break unit). It can be avoided by adjust smaller proportion gain and longer integral time.

F8.28	ASR(VF) adjustment upper limit frequency	Setting range: 0.00-20.00Hz	Factory set: 5.00Hz
-------	--	-----------------------------	---------------------

The parameter is used to limit the maximum frequency compensation in V/F with PG control. Motor rated slip is the parameter reference value 100%. Increasing slip limit when the load is heavy can effectively compensate rotary speed

and eliminate steady speed error. ASR (VF) adjustment upper limit frequency can be appropriately increased when high precision or heavy load are needed.

F8.29	Reserved
-------	----------

## 9.9 Malfunction and protection parameters

FA.00	Protection functionselection 1	Setting range: 0000-0111	Factory set: 1101
-------	--------------------------------	--------------------------	-------------------

### LED "0" digit: ACC OC protection selection

0: Invalid

1: **Valid** While inverter output frequency is over [FA.25] setting, inverter enters OC protection state, prolong ACC time and not continue ACC until frequency back to [FA.25] setting.

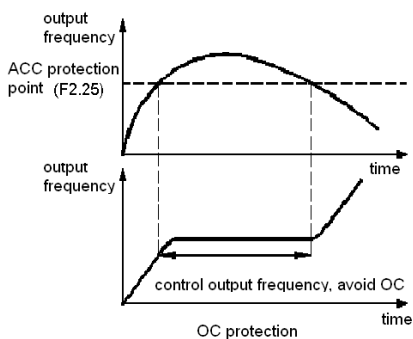

### LED "00" digit: DEC OC protection selection

While inverter output frequency is over [FA.26] setting, inverter enters OC protection state, prolong DEC time and not continue DEC until frequency back to [FA.26] setting.

0: Invalid

1: Valid

### LED "000" digit: current limit selection while running

While inverter output frequency is over [FA.27] setting, inverter enters current limit state, reduce output frequency according to [FA.28] ACC/DEC time setting and not continue ACC according to [FA.29] ACC/DEC time setting until frequency back to [FA.29] setting.

0: Invalid

1: Valid

### LED "0000" digit: current limit by control wave

It is a selection to choose whether current limit is valid or not. When valid, output current reaches to or bigger than 200% of inverter rated current, the function will work. At the same inverter will cut off output unless current is lower than 200% of inverter rated current.

0: Invalid

1: Valid

FA.01	Protection function selection 2	Setting range: 0000-3212	Factory set: 0001
-------	---------------------------------	--------------------------	-------------------

### LED "0" digi: DEC OV protection selection

**0: Invalid**

**1: rating 1 OV protection** Stronger OV protection. Bus voltage wave is small while protection.

**2: rating 2 OV protection** Strongest OV protection. Bus voltage wave is big while protection.

While it is valid and bus voltage is reach or over [FA.08], inverter will stop DEC.

**LED"00" digit: Protection selection for OV in ACC or constant speed**

**0: Invalid**

**1: Valid** While bus voltage is reach or over [FA.09], inverter will adjust frequency to protect. It is valid specially for eccentric load

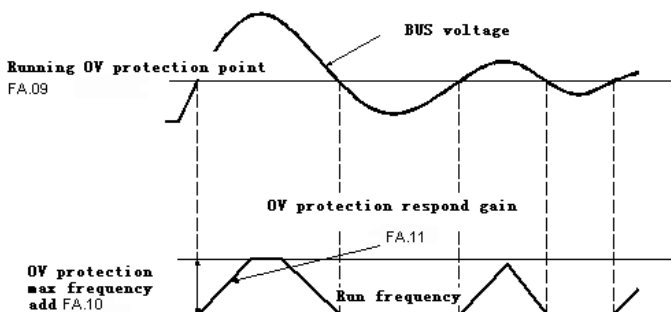

### OV PROTECTION SHOW

**Note:** Set right [FA.11] and [FA.12] parameters while using the OV protection.

**LED"000" digit: inverter OL act.** Set protection mode while over load.

**0: emergency stop output and alarm** While OL protection action is caused by too big output current of inverter, inverter stops output. Motor freely stop. And inverter alarm fault E.oL2.

**1: emergency stop and alarm** While OL protection action is caused by too big output current of inverter, inverter stops. Motor DEC stop. And inverter alarm fault E.oL2.

**2: limit current and run** While OL protection action is caused by too big output current of inverter, inverter switches to current limited run. Inverter makes output current be limited within rated current by reduce output frequency actively.

**LED "0000" digit: motor OL act**

**0: emergency stop output and alarm** While OL protection action is caused by too big output current of motor, inverter stops output. Motor freely stop. And inverter alarm fault E.oL1.

**1: emergency stop and alarm** While OL protection action is caused by too big output current of motor, inverter stops. Motor DEC stop. And inverter alarm fault E.oL1.

**2: limit current and run** While OL protection action is caused by too big output current of motor, inverter switches to current limited run. Inverter makes output current be limited within rated current by reduce output frequency actively.

**3: motor OL protection off**

**Note:** If "emergency stop and alarm" is selected while inverter or motor OL, inverter will do like this:

**1: After enter emergency stop state, inverter does not accept any orders including fault reset order until emergency stop state end.**

**2: In emergency stop process, fault signal is output immediately while multi function output terminal is set as**

**fault jump alarm 1. Fault signal is output after inverter DEC finished while multi function output terminal is set as fault jump alarm 2.**

**3: In emergency stop process, Keyboard LED displays fault information.**

FA.02	Protection function selection 3	Setting range: 0000-1112	Factory set: 0110
-------	---------------------------------	--------------------------	-------------------

**LED "0" digit: motor overload protection mode**

**0: Motor overload curve:** approach taken by the inverter overload the motor overload curve way to achieve overload protection. For more, see [FA.24].

**1: Set overload point protection:** when the inverter output current is less than [FA.24] overload setting point, normal running. when the inverter output current is less than [FA.24] overload setting point, inverter alarm immediately. For the alarm action please see [FA.01] LED"000" digit.

**LED"00" digit: input phase lack protection selection**

**0: Invalid**

**1: Valid** Stop inverter output and alarm fault E.I.LF while detect input phase lack.

**LED"000" digit: output phase lack protection selection**

**0: Invalid**

**1: Valid** Stop inverter output and alarm fault E.o.LF while detect output phase lack.

**LED"0000" digit: reserved**

FA.03	Protection function selection 4	Setting range: 0000-0011	Factory set: 1100
-------	---------------------------------	--------------------------	-------------------

**LED "0" digit: SC protection selection**

**0: Invalid**

**1: Valid.** Inverter judges E.SC alarm and removes disturbabce, only alarm for real fault signal. This function maybe delay alarm time. Please ust it carefully.

**LED"00" digit: OC protection selection**

**0: Invalid**

**1: Valid** Inverter judges OC alarm and remove disturbabce, only alarm for real fault signal. This function maybe delay alarm time. Please ust it carefully.

**LED"000" digit: current oscillation suppression**

**When valid,output current will keep more stability**

**0. Invalid**

**1. Valid**

**LED"0000" digit: reserved**

FA.04	Reserved		
-------	----------	--	--

FA.05	Fan control	Setting range: 0-2	Factory set: 1
-------	-------------	--------------------	----------------

Select fan run mode.

**0: Fan run after electrify** No matter temperature of module is high or not, fan runs while inverter power on.

**1: Fan stop related to temperature** Work while running. While inverter stops, fan runs while module temperature is over 50 degree and stops 30 seconds after module temperature is lower than standard. While inverter runs, fan runs.

**2: Fan stop while machine stop, run related to temperature** When inverter runs, fan runs while module temperature is over 50 degree and stops 30seconds after module temperature is lower than standard. When inverter stops, fan

stops.

**Note: This function can prolong fan life.**

FA.06	Bus under voltage protection value	Setting range: 50.0-100.0%	Factory default: 60.0%
-------	------------------------------------	----------------------------	------------------------

This parameter specifies the lower limit voltage allowed by bus voltage when the drive runs normally, and for some low power occasions, under voltage protection level can be appropriately reduced to ensure that the drive is working properly.

**Note: When the grid voltage is too low, the motor output torque will decrease. For constant power load and constant torque load, low grid voltage will increase the frequency converter input and output current, thereby reducing the reliability of the inverter operation.**

FA.07	Energy braking action voltage	Setting range: 115.0-150.0%	Factory default: According to model
-------	-------------------------------	-----------------------------	-------------------------------------

**Energy braking act voltage:** Inverter energy braking begins when DC bus voltage rise up and over rated. Voltage [FA.07] setting. Voltage is DC20V lower than [FA.07] setting when energy braking stops. Please set it carefully. It is only valid for inverter with inner braking parts. Inverters under AC80C-T3-018G have build in braking parts. AC80C-S2-3R7G and inverters under than that with 220V input have built in braking parts. All inverters do not have resistances. If need energy braking, please use optional resistance.

**Note: If use energy braking, please close OV protection function, which means set [FA.01] LED "0" digit and "00" digit as 0. Energy braking only be valid in running, invalid when stop.**

FA.08	Deceleration OV suppression point	Setting range:110-150%	Factory default:According to model
FA.09	Acceleration and constant speed OV suppression point	Setting range: 100.0-150.0%	Factory default:120.0%

The parameter is defined as the ratio between OV suppression start voltage and inverter DC bus rated voltage.

$$\text{Inverter DC bus rated voltage} = \text{inverter input rated voltage} \times 1.414$$

**DEC OV protection:** Set OV protection point when DEC. Only valid when [FA.01] LED "0" digit is 1 or 2.

**Acceleration and constant speed OV suppression point:** Set OV suppression point when ACC or running at constant speed. Only valid when [FA.01] LED "0" digit is 1.

FA.10	Acceleration and constant speed OV suppression plus frequency max amplitude	Setting range: 0.00-20.00Hz	Factory default: 2.00Hz
-------	---	-----------------------------	-------------------------

**Acceleration and constant speed OV suppression plus frequency max amplitude:** During acceleration and constant speed, when the bus voltage is greater than [FA.09] set value, the inverter bus voltage will be suppressed by increasing the operating frequency. Overvoltage suppression plus frequency max amplitude is used to limit the maximum increasing amplitude.

Increasing this value can improve suppression when there's large, setting this value is too large bus voltage fluctuation. Setting too big of the value may cause speed volatility. Reasonable set of OV suppression plus frequency max amplitude can effectively suppress overvoltage when ensuring small speed fluctuation.

**NOTE:**

- [FA.10] parameters should be properly adjusted according to the bus voltage fluctuation range, overvoltage would be increased if the value is set too big. If in the debugging process the plus frequency value has reached the maximum amplitude, [FA.10] parameters should be increased when bus voltage continues to rise.

2. When the bus voltage of the inverter rises quickly or OV suppression plus frequency process, and when the bus voltage rises without slowing trend, [FA.11] acceleration and constant speed overvoltage suppression response gain should be increased to increase suppression response speed.
3. In debugging process, [FA.10-FA.11] parameters adjustment cooperates can reach the best results of acceleration and constant speed OV suppression.

FA.11	Acceleration and constant speed OV suppression response gain	Setting range:0.00-10.00	Factory default: 0.50
FA.12	Acceleration and constant speed OV suppression integral time	Setting range: 0.00-10.00s	Factory default: 0.00s

Using tracking adjustment mode in voltage suppression process, the inverter automatically adjust the plus frequency process according to the bus voltage incremental rate and bus voltage measured values. Increasing [FA.11] or decreasing [FA.12] can improve OV suppression, but the speed volatility will increase. Decreasing [FA.11] or increasing [FA.12] can maintain process and speed fluctuation is small, but the OV suppression response is slow.

**Note: OC might occur if the OV suppression response gain is set too high in acceleration and constant speed when debugging. If there's OC in the process of OV, [FA.10] acceleration and constant speed OV suppression plus frequency max amplitude should be appropriately increased and the acceleration and constant speed OV suppression response gain should be appropriately decreased.**

FA.13- FA.14	Reserved
--------------	----------

FA.15	Malfunction auto-reset times	Setting range: 0-5	Factory default: 0
FA.16	Malfunction auto-reset interval	Setting range: 0.1-100.0s	Factory default: 1.0s

#### Malfunction auto-reset times:

0: Off No automatic reset function; manual reset.

1-5: On 1-5 is the automatic reset times;

The inverter would fail or stop during operation due to load fluctuations, voltage fluctuations and other factors. At this time in order to ensure continuity of system operation, automatic resets of inverter for overload, over current, system abnormalities, overvoltage, under voltage faults are allowed. The inverter would restart by speed tracking in the process of self recovery. If the inverter can't restart within the set times, stop output for fault protection; Fault recovery times can be set up to five times, after 10 minutes running the fault recovery times would be re-recorded and the times before is automatically cleared. Consecutive failures of restarting might cause harm, so the proposed fault recovery time is 1;

Output terminal can be selected to act or not act in automatic reset process. Details refer to [F2.29-F2.31].

**Malfunction auto-reset interval:** It defines waiting time before resetting after fault.

**Note: 1.Only valid for fault of OL, OC, system abnormal, under voltage. Not valid for other faults.**

**2. Can't reset before dealing with malfunction.**

**Attention: Please use this function carefully in occasions that can't start with load, or that needs alarm immediately when there's no output.**

FA.17	Instant loss power deceleration action voltage threshold value	Setting range: 0-100%	Factory default: 70%
-------	--	-----------------------	----------------------

FA.18	Reserved		
-------	----------	--	--

FA.19	Instant loss power deceleration gain	Setting range: 0.00-50.00	Factory default: 0.00
-------	--------------------------------------	---------------------------	-----------------------

Instantaneous power failure function is in the case of instantaneous power failure or sudden drop in voltage, the drive output frequency decreases, load feedback energy and lower compensation voltage to maintain continuous running in a short period.

When the input voltage is lower than [FA.17], the inverter begins to decelerate and bus voltage rises, [FA.19] is defined as the deceleration time gain; the bigger the parameter, the faster the voltage rising, suitable for small inertia loads; the smaller the parameter, the slower the voltage rising, suitable for large inertia loads.

FA.20-FA.21	Reserved		
-------------	----------	--	--

FA.22	Current surge suppression gain	Setting range: 0.0-500.0%	Factory default: 100.0%
-------	--------------------------------	---------------------------	-------------------------

When [FA.03] LED '000' select current surge suppression valid, the current surge suppression response speed can be increased by increasing [FA.22] .

FA.23	Deceleration time when wave by wave current limit	Setting range: 0.01-300.00s	Factory default: 2.00s
-------	---	-----------------------------	------------------------

The parameter defines the output frequency falling deceleration time when wave by wave current limit.

FA.24	Motor overload protection coefficient	Setting range: 20.0-250.0%	Factory default:100.0%
-------	---------------------------------------	----------------------------	------------------------

Motor overload for long time would cause serious heat; this parameter is used to set the coefficient when the drive implements heat relay protection on load motor; motor overload protection time and overload coefficient have inverse time characteristic curve; when the overload coefficient = 116% lasting 1 hour reporting overload fault; when the overload coefficient = 200% lasting 1 minute reporting overload fault, as shown below:

**Overload coefficient = load current / (motor rated current × motor overload protection coefficient)**

**Motor overload protection coefficient = motor protection current / motor rated current**

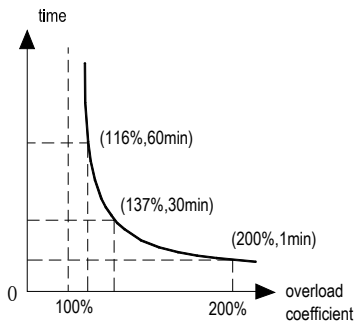

inverse time characteristic curve diagram



**Note:** When one inverter is running parallel with multiple motors, the heat relay protection function of the inverter will be out of action, in order to effectively protect the motor, please install a heat protection relay at the end of each motor.

FA.25	ACC OC suppression point	Setting range: 100-250%	Factory default: 160%
FA.26	DEC OC suppression point	Setting range: 100-250%	Factory default: 160%
FA.27	Running constant torque area current limit point	Setting range: 100-250%	Factory default: 160%
FA.28	Running constant power area current amplitude limit coefficient	Setting range: 20-200%	Factory default: 100%
FA.29	Current amplitude limit frequency ACC/DEC time	Setting range: 0.01-300.00s	Factory default: 0.50s
FA.30	Current amplitude limit PI gain coefficient	Setting range: 0-20000	Factory default: According to model
FA.31	Current amplitude limit PI integral coefficient	Setting range: 0-20000	Factory default: According to model

OC suppression point is defined as the ratio of inverter output current and rated current.100% is the rated current of inverter.

**ACC OC suppression point:** used to set ACC OC suppression point

**DEC OC suppression point:** used to set DEC OC suppression point

**Running constant torque area current limit point:** used to set running constant torque area OC amplitude limit

**Running constant power area current amplitude limit coefficient:** used to set running constant power area OV amplitude limit coefficient the frequency ACC/DEC time.

**Current amplitude limit PI gain coefficient:**

**Current amplitude limit PI integral coefficient:** used to adjust the change of the current limit amplitude output frequency. the bigger the gain/integral coefficient, the faster the output frequency response but there might be current surge; the smaller the gain/integral coefficient, the slower the output frequency response but the current amplitude limit might not be so affective.

FA.32-FA.33	Reserved		
-------------	----------	--	--

FA.34	Fault single phase current instant max value	0.1-2000.0A	--
FA.35	Fault type	See fault code list	--
FA.36	Fault running frequency	0.00-max frequency	--
FA.37	Fault output voltage	0-1500V	--
FA.38	Fault output current	0.1-2000.0A	--
FA.39	Fault bus voltage	0-3000V	--
FA.40	Fault module temperature	0-100℃	--

FA.41	Fault inverter status	<p>LED "0" digit: run direction  0: FWD  1: REV</p> <p>LED*00" digit: run status  0: stop  1: steady speed  2: ACC  3: DEC</p> <p>LED*000" digit: process status  1: parameter identifying  2: jogging  3: current limit wave by wave</p> <p>LED*0000" digit: output loss phase status  0: n o loss phase  1: U loss phase  2: V loss phase  3: W loss phase</p>	---
FA.42	Fault input terminal status	See input terminal chart	---
FA.43	Fault output terminal status	See output terminal chart	---
FA.44	The last malfunction types	See fault code list	---
FA.45	The last malfunction running frequency	0.00-max frequency	---
FA.46	The last malfunction output voltage	0-1500V	---
FA.47	The last malfunction output current	0.1-2000.0A	---
FA.48	The last malfunction bus voltage	0-3000V	---
FA.49	The last malfunction module temperature	0-100°C	---
FA.50	The last malfunction machine state	Same as [FA.41]	---
FA.51	The last malfunction input terminal state	See input terminal chart	---
FA.52	The last malfunction output terminal state	See output terminal chart	---
FA.53	The first two malfunction types	See fault code list	---
FA.54	The first three malfunction types	See fault code list	---

**Note: Malfunction records can be cleared by [F0.19]. See [F0.19] details.**

## 9.10 Machine malfunction code table

Communication code	Malfunction code	Malfunction LED code	Malfunction name
0	--	--	No fault
1	L.U.1	L.U.1	Under-voltage at stop
2	E.LU2	E.LU2	Under-voltage while running
3	E.oU1	E.oU1	Over-voltage while ADD
4	E.oU2	E.oU2	Over-voltage while DEC
5	E.oU3	E.oU3	Over-voltage at constant speed
6	E.oU4	E.oU4	Over-voltage at stop
7	E.oC1	E.oC1	Over-current while ADD
8	E.oC2	E.oC2	Over-current while DEC
9	E.oC3	E.oC3	Over-current at constant speed
10	E.oL1	E.oL1	Motor overload
11	E.oL2	E.oL2	Frequency inverter overload
12	E. SC	E. SC	System abnormal
13	E.oH1	E.oH1	Inverter overheat
14	E.oH2	E.oH2	Rectifier bridge overheat
15	E.IE1	E.IE1	Motor detect malfunction at static state
16	E.IE2	E.IE2	Motor detect malfunction circularly
17	E.EEP	E.EEP	Store malfunction
18	L.IFE	L.IFE	Reserved
19	E.ILF	E.ILF	Input side phase lack
20	E.oLF	E.oLF	Output side phase lack
21	E.GnD	E.GnD	Output earth
22	E.HAL	E.HAL	Current detection fault
23	E.EF	E.EF	Exterior fault
24	E.PAn	E.PAn	Keyboard connection fault
25	E.CE	E.CE	Rs485 communication fault
26	E.CPE	E.CPE	Parameter copy fault
27	E.ECF	E.ECF	Optional card connection fault
28	E.PG	E.PG	PG card connection fault
29	E.PID	E.PID	PID feedback wire connection fault
30	E.EDI	E.EDI	Copy software not compatible

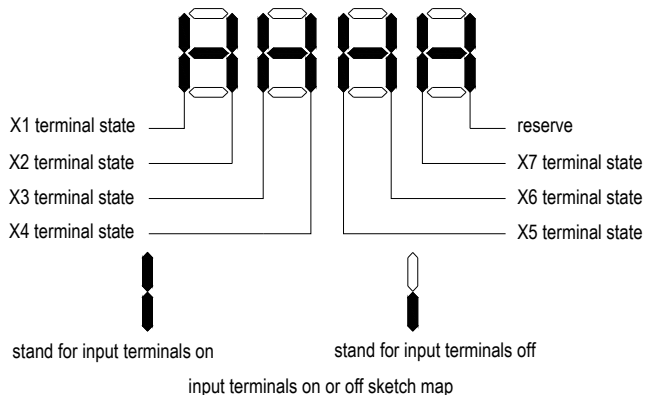
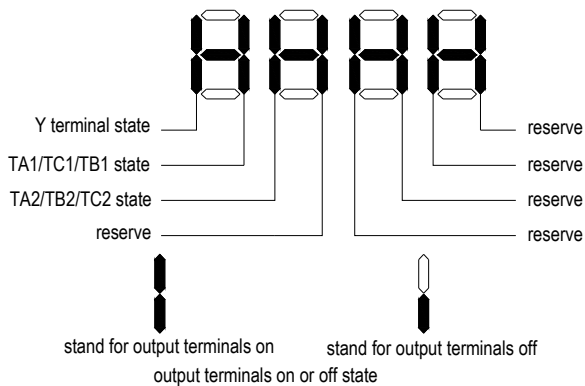
**Input terminal on/off show diagram:****Output terminal on/off show diagram:**

## 9.11 PID parameters

PID control is used for process control mode normal. For the aim of that the object which be controlled is stabilized as the PID given, it adjusts inverter output frequency to form passive feedback PID adjustment by series of proportional, integral, differential calculation by difference between the feedback of that be controlled and the inverter PID given.

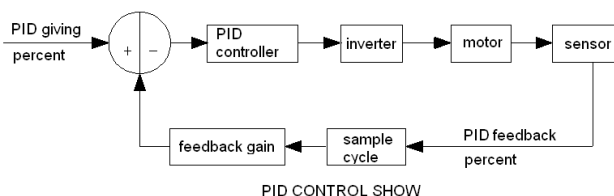

Fb.00	PID give signal source	Setting range: 0-8	Factory set: 0
-------	------------------------	--------------------	----------------

Use to set the input channel of PID controller given signal.

0: Keyboard number given PID Decided by **[Fb.01]** setting.

1: Keyboard potentiometer

2: Terminal VS voltage analog

3: Terminal AI analog

4: Terminal AS current analog

5: Terminal PUL pulse signal

6: RS485 communication

7: Optional card

8: Terminal selection PID giving is selected by multifunction input terminal combine which is set by **[F2.00-F2.06]**.

**Terminal switch table:**

Terminal 3	Terminal 2	Terminal 1	PID giving terminal switch selection
OFF	OFF	OFF	Keyboard number give PID
OFF	OFF	ON	Keyboard potentiometer
OFF	ON	OFF	Terminal VS voltage analog
OFF	ON	ON	Terminal AI analog
ON	OFF	OFF	Terminal AS current analog
ON	OFF	ON	Terminal PUL pulse signal
ON	ON	OFF	RS485 communication
ON	ON	ON	Optional card

Fb.01	Keyboard number give PID	Setting range: 0.00-100.0%	Factory set: 50.0%
-------	--------------------------	----------------------------	--------------------

This function is valid only when **[Fb.00]/[Fb.02]** is set as keyboard number given/feedback. It is based on feedback signal max range **[Fb.04]**. After this parameter is changed, PID given in monitor object is modified automatical at the same time.

If **[Fb.04]** LED "0" is set as 3, this value can be modified by UP/DW key. Whether save the modification is decided by **[F4.04]** LED "00" digit.

Fb.02	PID feedback signal source	Setting range:0-8	Factory set:2
-------	----------------------------	-------------------	---------------

**Set PID feedback signal input channel.**

**0: Keyboard number given PID** PID feedback channel decided by [Fb.01].

**1: Keyboard potentiometer**

**2: Terminal VS voltage analog**

**3: Terminal AI voltage analog**

**4: Terminal AS current analog**

**5: Terminal PUL pulse signal**

**6:RS485 communication** PID feedback channel decided by RS485.Communication address is H3009 or H2009.

**7: Optional card**

**8: Terminal selection** PID feedback channel decided by multifunction input terminal combination. Multifunction input terminal is set by [F2.00-F2.06].

**Terminal switch table:**

Terminal 3	Terminal 2	Terminal 1	PID giving terminal switch selection
OFF	OFF	OFF	Keyboard number give PID
OFF	OFF	ON	Keyboard potentiometer
OFF	ON	OFF	Terminal VS voltage analog
OFF	ON	ON	Terminal AI analog
ON	OFF	OFF	Terminal AS current analog
ON	OFF	ON	Terminal PUL pulse signal
ON	ON	OFF	RS485 communication
ON	ON	ON	Optional card

**Note:** PID controller given signal source and PID controller feedback signal source can not be the same channel. Otherwise PID can not work normally.

Fb.03	Feedback signal gain	Setting range: 0.00-10.00	Factory set: 1.00
-------	----------------------	---------------------------	-------------------

It is used to magnify or reduce feedback channel input signal.

Fb.04	Feedback signal max measuring range	Setting range: 0-100.0	Factory set: 100.0
-------	-------------------------------------	------------------------	--------------------

It is used to revise the display data of PID given and PID feedback.

$$\text{Display data} = \frac{\text{give/feedback signal-lowest limit value for this channel}}{\text{highest limit value for this channel-lowest limit value for this channel}} \times \frac{\text{max sensor measuring range}}{\text{measuring range}}$$

For example: Under pressure control, while it is set as sensor max measuring range, it displays actual pressure.

If VS is feedback signal input channel, while VS highest limit is 9V, lower limit is 0.5V, feedback voltage is 4.5V, and sensor measuring range is 20mpa.

$$\text{Display value} = (4.5-0.5) \times 20/(9-0.5) = 9.4\text{mpa}$$

Fb.05	PID output trait selections	Setting range: 0000-0011	Factory set: 0100
-------	-----------------------------	--------------------------	-------------------

**LED "0" digit: feedback trait**

**0: Positive trait.** It is suitable for occasions where PID feedback is bigger than PID given and requires reduce output frequency PID to balance PID. Such as constant pressure water supply, gas supply, take-up tension control.

**1: Negative trait.** It is suitable for occasions where PID feedback is bigger than PID given and requires raise output

frequency PID to balance PID. Such as constant temperature control, pay-off tension control.

#### LED "00" digit: PID direction adjustment

0: REV forbid

1: REV permit

Inverter control output frequency after given signal and feedback signal calculation according to PID control mode setting while receiving the run order. If REV forbid (**[F0.07]** LED "00" digit is 0 frequency control direction invalid or **[F0.16]** is 2 REV forbid), inverter outputs 0.00Hz. If REV permit, inverter will change output direction, motor REV.

#### LED "000" digit: align

While PID setting is not at the centre point of 50%, error range of PID feedback and PID setting is non-symmetry state.

**0: not centre align** Not correct error.

**1: centre align** Correct error.

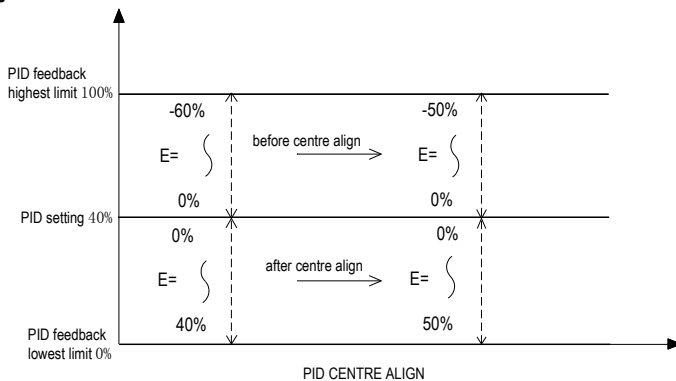

#### LED "0000" digit: reserved

Fb.06	PID preset frequency	Setting range: 0.00-max frequency	Factory set: 50.00Hz
Fb.07	PID preset frequency running time	Setting range: 0.0-6500.0s	Factory set: 0.0s

While it defines as PID start running, frequency ACC to PID pre-set frequency **[Fb.06]** according to ACC time 1. After setting **[Fb.07]** time, it runs as PID closed loop trait.

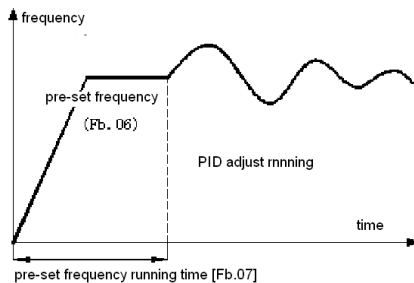

PID pre-set frequency running

Fb.08	Proportion gain: P	Setting range: 0.00-100.00	Factory set: 1.00
Fb.09	Integral time: I	Setting range: 0.01-10.00s	Factory set: 0.10s
Fb.10	Differential coefficient : D	Setting range: 0.00-10.00s	Factory set: 0.00s

**Proportion gain P:** It decides the impact of P act to bias. Response is quicker while gain is bigger. But there will be surge while it is too big. Response is slower while gain is smaller.

**Integral time I:** It decides the size of effect of I act. Response is slower and control ability for out disturbance while I is big. Response is quicker while I is small. But there will be surge if it is too small.

**Differential coefficient D:** While bias of PID feedback and PID given is changing, it adjusts change rate of output and bias pro rata. It is related to direction and size of bias change, not related to direction and size of bias itself. Use it carefully for it easily magnifies the disturbance.

Fb.11	Sample cycle	Setting range: 0.01-100.00s	Factory set: 0.10s
-------	--------------	-----------------------------	--------------------

It is only valid for PID feedback sample cycle. Response is quicker while cycle is smaller.

Fb.12	PID slip limit	Setting range: 0.0-100.0%	Factory set: 0.0%
-------	----------------	---------------------------	-------------------

While feedback is in this range, PID adjustment stops. Output does not change.

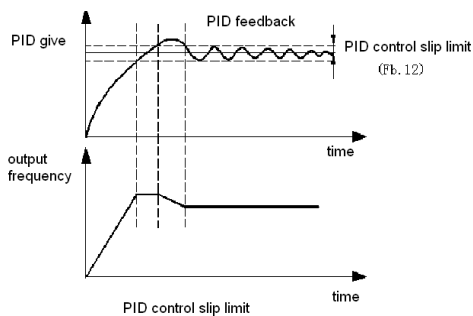

Fb.13	Reserved
-------	----------



Fb.14	Detection time while feedback wire break	Setting range: 0.0-120.0s	Factory set: 1.0s
Fb.15	Act selections while feedback wire break	Setting range: 0-3	Factory set: 0
Fb.16	Wire break alarm upper limit	Setting range: 0.0-100.0%	Factory set: 100.0%
Fb.17	Wire break alarm lowest limit	Setting range: 0.0-100.0%	Factory set: 0.0%

While PID given frequency and inverter is running, if feedback signal which is bigger the **[Fb.16]** or smaller than **[Fb.17]** is detected out and keeps for **[Fb.14]** delay time, it is considered as sensor wire break.

**Act selections while feedback wire break:**

0: Go on PID operation without alarm

1: Stop and alarm malfunction

2: Go on PID operation and output alarm signal

3: Run the current frequency and output alarm signal

**Wire break alarm upper limit:** Feedback signal is over alarm upper limit for time **[Fb.14]**, it is considered as sensor wire break.

**Wire break alarm lowest limit:** Feedback signal is under alarm upper limit for time **[Fb.14]**, it is considered as sensor wire break.

Fb.18	Stable pressure water-supplying dormancy system selections	Setting range: 0-1	Factory set: 0
Fb.19	Start-up value	Setting range: 0.0-100.0%	Factory set: 0.0%
Fb.20	Dormancy detection value coefficient	Setting range: 0.0-1.000	Factory set: 0.900
Fb.21	Dormancy detection DEC time	Setting range: 0.0-6500.0s	Factory set: 30.0s
Fb.22	Dormancy detection low point hold frequency	Setting range: 0.00-20.00Hz	Factory set: 10.00Hz

**Stable pressure water-supplying dormancy system selections:** It sets whether use dormancy system while PID for stable pressure water-supplying. While use, inverter start dormancy detection if PID feedback higher or equal to PID setting for a certain time. In dormancy detection process, if feedback is bigger than detection value, inverter reduces output frequency to **[Fb.22]** for a while. If PID feedback is still higher than detection value, inverter reduces output frequency to 0.00Hz, enter to dormancy state. In this process, if feedback is lower than detection value, dormancy detection is invalid. Inverter is back to PID adjustment state.

**0: Invalid**

**1: Valid**

**Start-up value:** While inverter enters dormancy system, PID feedback must be lower then start-up value. Otherwise inverter can not start. If start-up value is too high, it maybe causes inverter frequency start and stop. But if it is too low, it maybe causes under-pressure. It is defined as ratio of PID feedback to sensor max measuring range.

**Dormancy detection value coefficient:** In process that inverter enters dormancy system in mode of reducing output frequency, once PID feedback is lower dormancy detection value, inverter back to PID adjustment state. If it set as 1.000, system takes PID setting as exit value in frequency reduce state. Dormancy detection value is defined as the result of this value multiples PID given.

**Dormancy detection DEC time:** Set DEC time for inverter reducing frequency in dormancy detection process.

**Dormancy detection low point hold frequency:** Set frequency that inverter holds at the low point in dormancy detection process.

## 9.12 Multistep, PLC function and swing frequency parameters

FC.00	Step 1	Setting range: 0.00-320.00Hz	Factory set: 10.00Hz
FC.01	Step 2	Setting range: 0.00-320.00Hz	Factory set: 20.00 Hz
FC.02	Step 3	Setting range: 0.00-320.00Hz	Factory set: 30.00 Hz
FC.03	Step 4	Setting range: 0.00-320.00Hz	Factory set: 40.00 Hz
FC.04	Step 5	Setting range: 0.00-320.00Hz	Factory set: 50.00 Hz
FC.05	Step 6	Setting range: 0.00-320.00Hz	Factory set: 40.00 Hz
FC.06	Step 7	Setting range: 0.00-320.00Hz	Factory set: 30.00 Hz
FC.07	Step 8	Setting range: 0.00-320.00Hz	Factory set: 20.00 Hz
FC.08	Step 9	Setting range: 0.00-320.00Hz	Factory set: 10.00 Hz
FC.09	Step 10	Setting range: 0.00-320.00Hz	Factory set: 20.00 Hz
FC.10	Step 11	Setting range: 0.00-320.00Hz	Factory set: 30.00 Hz
FC.11	Step 12	Setting range: 0.00-320.00Hz	Factory set: 40.00 Hz
FC.12	Step 13	Setting range: 0.00-320.00Hz	Factory set: 50.00 Hz
FC.13	Step 14	Setting range: 0.00-320.00Hz	Factory set: 40.00 Hz
FC.14	Step 15	Setting range: 0.00-320.00Hz	Factory set: 30.00 Hz

It sets run frequency of 15 steps in PLC and multistep control.

Multistep control has priority only after JOG. While multistep control, 4 multifunction input terminals are needed to set as control terminals. Set details refer to **[F2.00-F2.06]**.

Inverter is running at which step is decided by the ON/OFF state of 4 control terminal and **COM**. Run and direction is controlled by run signal and direction given by **[F0.02]**. ACC/DEC time default is ACC/DEC time 1 **[F0.14]**, **[F0.15]**. Or select ACC/DEC time by ACC/DEC time selection terminal set by **[F2.00-F2.06]**.

Multi steps terminal 4	Multi steps terminal 3	Multi steps terminal 2	Multi steps terminal 1	terminal speed
OFF	OFF	OFF	ON	1X <b>[FC.00]</b>
OFF	OFF	ON	OFF	2X <b>[FC.01]</b>
OFF	OFF	ON	ON	3X <b>[FC.02]</b>
OFF	ON	OFF	OFF	4X <b>[FC.03]</b>
OFF	ON	OFF	ON	5X <b>[FC.04]</b>
OFF	ON	ON	OFF	6X <b>[FC.05]</b>
OFF	ON	ON	ON	7X <b>[FC.06]</b>
ON	OFF	OFF	OFF	8X <b>[FC.07]</b>
ON	OFF	OFF	ON	9X <b>[FC.08]</b>
ON	OFF	ON	OFF	10X <b>[FC.09]</b>
ON	OFF	ON	ON	11X <b>[FC.10]</b>
ON	ON	OFF	OFF	12X <b>[FC.11]</b>

ON	ON	OFF	ON	13X [FC.12]
ON	ON	ON	OFF	14X [FC.13]
ON	ON	ON	ON	15X [FC.14]

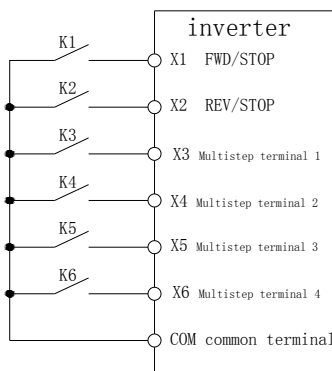

Terminal connection

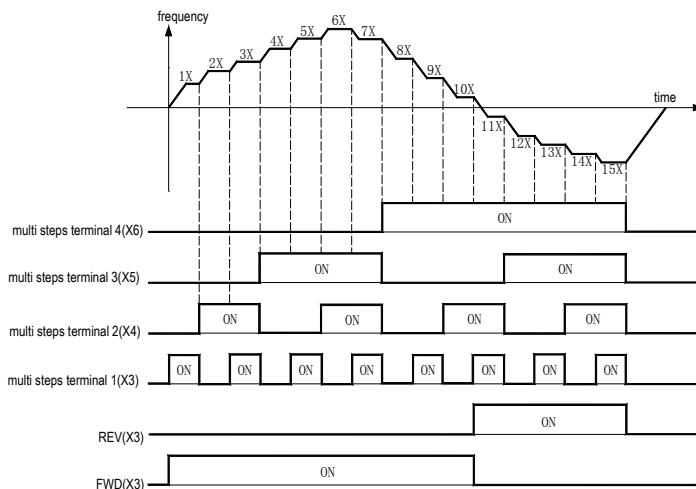

MULTI STEP TIME ORDER

FC. 15	PLC run mode selections	Setting range: 0000-2212	Factory set: 0000
--------	-------------------------	--------------------------	-------------------

**LED "0" digit: cycle mode**

**0: Stop after single cycle** While receiving order, inverter run from the first step, time unit is set by [FC.15] LED "00" digit. Running time is set by [FC.16-FC.30]. Running direction and ACC/DEC time is selected by [FC.31-FC.45]. Turn to next step while run time is over, run time, direction, ACC/DEC time of every step can be set separately. Inverter output 0 Hz while finished 15 steps running. If one step running time is 0, it will skip this step.

**1: Continuous cycles** Inverter not stop and runs at the latest speed while finished 15 steps running. Time unit is set by [FC.15] LED "00" digit. Run time is set by [FC.16-FC.30]. Run direction and ACC/DEC time is selected by [FC.31-FC.45].

**2: Keep final value after single cycle** Inverter back to 1<sup>st</sup> step while finished 15 steps running. Time unit is set by [FC.15] LED "00" digit. Run time is set by [FC.16-FC.30]. Run direction and ACC/DEC time is selected by [FC.31-FC.45].

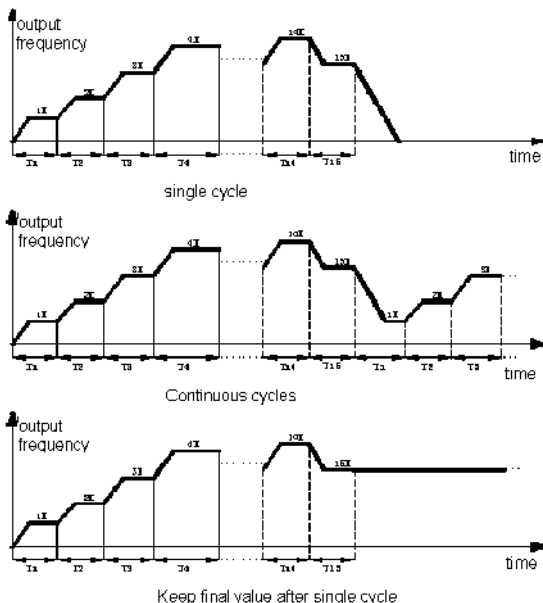

LED"00"digit: Time unit

0: second

1: minute

2: hour

LED"000"digit: Power down save mode

0: no save

1: save

Decide whether save running state while power down. If save, define recover mode by [FC.15] LED "0000" digit. If need continue the state before power off, this parameter should be set as 1.

LED"0000"digit: Start-up mode

0: Restart from the 1st step

1: Restart from the step where stop

2: Restart from the time when stop

Set restart mode while stop for some reasons (stop, fault, power off and so on).

**Output frequency is limited by upper/lowest limitation. While frequency is lower than lowest limitation, it runs as [F0.13] lowest limitation mode.**

FC.16	PLC 1st step running time	Setting range: 0.0-6500.0(s/m/h)	Factory set: 10.0
FC.17	PLC 2nd step running time	Setting range: 0.0-6500.0(s/m/h)	Factory set: 10.0

FC.18	PLC 3rd step running time	Setting range: 0.0-6500.0(s/m/h)	Factory set: 10.0
FC.19	PLC 4th step running time	Setting range: 0.0-6500.0(s/m/h)	Factory set: 10.0
FC.20	PLC 5th step running time	Setting range: 0.0-6500.0(s/m/h)	Factory set: 10.0
FC.21	PLC 6th step running time	Setting range: 0.0-6500.0(s/m/h)	Factory set: 10.0
FC.22	PLC 7th step running time	Setting range: 0.0-6500.0(s/m/h)	Factory set: 10.0
FC.23	PLC 8th step running time	Setting range: 0.0-6500.0(s/m/h)	Factory set: 10.0
FC.24	PLC 9th step running time	Setting range: 0.0-6500.0(s/m/h)	Factory set: 10.0
FC.25	PLC 10th step running time	Setting range: 0.0-6500.0(s/m/h)	Factory set: 10.0
FC.26	PLC 11th step running time	Setting range: 0.0-6500.0(s/m/h)	Factory set: 10.0
FC.27	PLC 12th step running time	Setting range: 0.0-6500.0(s/m/h)	Factory set: 10.0
FC.28	PLC 13th step running time	Setting range: 0.0-6500.0(s/m/h)	Factory set: 10.0
FC.29	PLC 14th step running time	Setting range: 0.0-6500.0(s/m/h)	Factory set: 10.0
FC.30	PLC 15th step running time	Setting range: 0.0-6500.0(s/m/h)	Factory set: 10.0

Set running time of every 15 step. Time unit is decided by **[FC.15]** LED "00" digit setting.

FC.31	PLC 1st step direction and ADD/DEC time	Setting range:0000-0031	Factory set: 0000
FC.32	PLC 2nd step direction and ADD/DEC time		Factory set: 0000
FC.33	PLC 3rd step direction and ADD/DEC time		Factory set: 0000
FC.34	PLC 4th step direction and ADD/DEC time		Factory set: 0000
FC.35	PLC 5th step direction and ADD/DEC time		Factory set: 0000
FC.36	PLC 6th step direction and ADD/DEC time		Factory set: 0000
FC.37	PLC 7th step direction and ADD/DEC time		Factory set: 0000
FC.38	PLC 8th step direction and ADD/DEC time		Factory set: 0000
FC.39	PLC 9th step direction and ADD/DEC time		Factory set: 0000
FC.40	PLC 10th step direction and ADD/DEC time		Factory set: 0000
FC.41	PLC 11th step direction and ADD/DEC time		Factory set: 0000
FC.42	PLC 12th step direction and ADD/DEC time		Factory set: 0000
FC.43	PLC 13th step direction and ADD/DEC time		Factory set: 0000
FC.44	PLC 14th step direction and ADD/DEC time		Factory set: 0000
FC.45	PLC 15th step direction and ADD/DEC time		Factory set: 0000

Set running direction and ACC/DEC time of every 15 step while running.

**LED "0" digit: this step run direction**

**0: FWD**

**1: REV**

If **[F0.07]** LED "00" digit is 0 or **[F0.16]** is 2, and this setting is 1 REV, inverter runs as 0.00Hz.

**LED "00" digit: ACC/DEC time in this step**

0: ACC/DEC time 1

1: ACC/DEC time 2

2: ACC/DEC time 3

4: ACC/DEC time 4

**LED "000" digit: reserved**

**LED "0000" digit: reserved**

FC.46-FC.52	Reserved
-------------	----------

### 9.13 Communication control function parameters

Fd.00	Main-slave machine	Setting range: 0-1	Factory set: 0
-------	--------------------	--------------------	----------------

Take inverter as main machine or slave machine while Modbus communication. Details for Modbus, refer to Appendix 2:RS485 communication protocol.

**0: Slave machine** Inverter is slave machine. Communication address is decided by [Fd.01]. Inverter accepts order from main machine and reply or not while writing operation according [Fd.08] setting. Reply delay time is set by [Fd.05].

**1: Main machine** Inverter, as main machine, sends data to communication net by broadcast orders. All slave machines accept orders from main machine. Main machine sending data is set by [Fd.09].

Fd.01	Machine address	Setting range: 1-247	Factory set: 1
-------	-----------------	----------------------	----------------

It set communication address while inverter is slave machine. If inverter is main machine, this parameter is no meaning. 0 is broadcast address.

Fd.02	Communication baud rate selections	Setting range: 0-5	Factory set: 3
-------	------------------------------------	--------------------	----------------

0:1200 bps  
 1:2400 bps  
 2:4800 bps  
 3:9600 bps  
 4:19200 bps  
 5:38400 bps

Fd.03	Data format	Setting range: 0-5	Factory set: 0
-------	-------------	--------------------	----------------

0: (N, 8, 1) no checkout, Data digit: 8, Stop digit: 1  
 1: (E, 8, 1) even checkout, Data digit: 8, Stop digit: 1  
 2: (O, 8, 1) odd checkout, Data digit: 8, Stop digit: 1  
 3:(N,8,2) no checkout,Data digit:8, Stop digit:2  
 4:(E,8,2) even checkout,Data digit:8, Stop digit:2  
 5:(O,8,2) odd checkout,Data digit:8, Stop digit:2

Fd.04	Communication ratio setting	Setting range: 0.00-5.00	Factory set: 1.00
-------	-----------------------------	--------------------------	-------------------

The result of upper machine multiply this parameter is communication giving or feedback of this machine. Upper machine communication order can be modified pro rate.

Fd.05	Communication answer delay	Setting range: 0-500ms	Factory set: 0ms
-------	----------------------------	------------------------	------------------

While delay time is shorter than system dealing time, real delay time is same as system dealing time. While delay time is longer than system dealing time, it has to delay while system dealing finished. It does not send data to upper machine

until delay time arrive.

Fd.06	Communication overtime fault time	Setting range: 0.1-100.0s	Factory set: 1.0s
Fd.07	RS485 communication fault act mode selections	Setting range: 0-3	Factory set: 1

**Communication overtime fault time:** If the interval between one communication and next communication is over communication overtime, it is considered as communication break fault. **[Fd.07]** decides the act mode.

#### RS485 communication fault act mode selections

**0: Alarm and stop freely** If it has not received next frame order or ther communication order while the latest communication giving order is over **[Fd.06]** time setting, inverter alarms fault E.CE and stops.

**1: Not alarm, go on run** Inverter does not inspect fault and always runs according the latest order.

**2: Stop without alarm 1** If it has not received next frame order or ther communication order while the latest Communication giving order is over **[Fd.06]** time setting.inverter will clear orders before and back to standby state.

**3: Stop without alarm2** Frequency inverter stop while communication giving order is over than**[Fd.06]** setting time and does not receive next frame order or other communication order.

Fd.08	Transmission response	Setting range:0-1	Factory set: 0
-------	-----------------------	-------------------	----------------

It decides whether inverter responds while upper machine send write order.

**0: write operation with response**

**1: write operation without response**

Fd.09	Main machine sending selections	Setting range: 0000-AAAA	Factory set: 0031
-------	---------------------------------	--------------------------	-------------------

Set the data that inverter sends the slave machines while inverter is main machine.

#### LED "0" digit: 1st group of frame selection

0: invalid

1: run order give

2: main machine give frequency

3: main machine output frequency

4: main machine max frequency

5: Reserved

6: main machine output torque

7: Reserved

8: Reserved

9: main machine give PID

A: main machine feedback PID

**LED "00" digit: 2nd group of frame selection** as above

**LED "000" digit: 3rd group of frame selection** as above

**LED "0000" digit: 4th group of frame selection** as above

Fd.10- Fd.12	Reserved
--------------	----------

## Chapter 10 Appendix

“●”: Parameter can be changed in the running state.

“○”: Parameter can't be changed in the running state.

“×”: Parameter can be read only.

“—”: Factory setting parameter, only factory can set.

“※”: Parameter is related to the model.

### Basic parameters

NO.	Function description	Range of settings and definition	Factory setting	Attribute	Reference page	Communication add
F0.00	Control mode	0: V/F without PG 1: VC without PG 2: Reserved 3: V/F with PG 4: VC with PG 5: Reserved	1	○	75	0x000
F0.01	Reserved				75	0x001
F0.02	Run command channel	0: Keyboard control 1: Terminal control 2: RS485 communication control 3: Optional card 4: Terminal switching	0	○	75	0x002
F0.03	Frequency given main channel selection	0: Keyboard number given 1: Keyboard potentiometer given 2: Terminal VS voltage analog given 3: Terminal AI analog given 4: Terminal AS current analog given 5: Terminal pulse signal given 6: RS485 communication port given 7: UP/DW control given 8: PID control given 9: Program control given 10: Reserved 11: Optional card given 12: Terminal selection	0	○	76	0x003
F0.04	Main channel gain	0.000-5.000	1.000	○	78	0x004
F0.05	Frequency given auxiliary channel selection	0: Keyboard digital given 1: Keyboard potentiometer given 2: Terminal VS voltage analog given 3: Terminal AI analog given 4: Terminal AS current analog given 5: Terminal pulse signal given 6: RS485 communication port given	1	○	78	0x005



F0.06	Auxiliary channel gain	0.000-5.000	1.000	○	78	0x006
F0.07	Frequency given channels combination mode	LED"0"digit: 0: Main channel valid 1: Auxiliary channel valid 2: Main + auxiliary 3: Main-auxiliary 4: MAX{ main, auxiliary } 5: MIN{ main, auxiliary } 6: Main*auxiliary LED"10"digit: 0: Direction of frequency control is invalid 1: Direction of frequency control is invalid LED"100"digit: Reserved LED"1000"digit: Reserved	0000	○	78	0x007
F0.08	Keyboard number setting frequency	0-upper limit	50.00 Hz	●	79	0x008
F0.09	Max frequency output	0-320.00Hz	50.00 Hz	○	79	0x009
F0.10	Upper limitation source selection	LED"0"digit: Main channel 0: Upper limit frequency digital given 1: Keyboard potentiometer given 2: Terminal VS voltage analog given 3: Terminal AI analog given 4: Terminal AS current analog given 5: Terminal pulse signal 6: RS485 communication given LED"00"digit: Whether auxiliary channel is limited by main channel 0.Upper is limited by main channel 1.Upper is not limited by main channel	0000	○	79	0x00A
F0.11	Upper limit frequency digital setting	Lower limit-max output frequency	50.00 Hz	○	79	0x00B
F0.12	low limit frequency	0-upper limit	0.00 Hz	○	79	0x00C
F0.13	low limit frequency running mode	0: Stop 1: Run as lower frequency limitation	1	○	79	0x00D
F0.14	ACC time 1	0.01-650.00s	According to model	●	80	0x00E
F0.15	DEC time 1	0.01-650.00s	According to model	●	80	0x00F
F0.16	Rotate direction	0: Consistent 1: Reverse 2: Reverse banned	0	●	81	0x010

F0.17	Carrier frequency	0.6-15.0kHz	According to model	●	81	0x011
F0.18	Carrier frequency characteristic selection	LED"0" digit: 0: Related to temperature 1: Unrelated to temperature LED"10" digit: 0: Related to frequency output 1: Unrelated to frequency output LED"100" digit: 0: Fixed carrier 1: Random carrier LED"1000" digit: PWM send wave mode 0: PWM mode 1 1: PWM mode 2 2: PWM mode 3	0010	●	82	0x012
F0.19	Parameter initialization	0: Not action 1: Recover factory setting 2: Clear malfunction records	0	○	82	0x013
F0.20	AVR function selection	0: invalid 1: all valid 2: valid in DEC only 3: Quick AVR adjust, all valid 4: Quick AVR adjust, invalid while DEC, valid while other state	2	●	82	0x014
F0.21	Over exciting while DEC	0:Invalid 1:Valid	0	●	83	0x015
F0.22	Over exciting setting current	50.0%-200.0%	115.0%	●	83	0x016
F0.23	Over exciting gain	0.0-10.00	According to model	●	83	0x017

### Run control parameters

NO.	Function description	Range of settings and definition	Factory setting	Attribute	Reference page	Communication add
F1.00	Start-up mode running	0: Start directly 1: Braking first then start by start frequency 2: Speed tracking , judge direction then start	0	○	84	0x100
F1.01	Start pre-excitation time	0.00-60.00s	According to model	●	84	0x101
F1.02	Start frequency	0.00-60.00Hz	0.50Hz	●	84	0x102
F1.03	Start frequency hold time	0.0-50.0s	0.0s	●	84	0x103
F1.04	Braking current before starting	0-150.0%	0.0%	●	84	0x104

F1.05	Braking time before starting	0.0-30.0s	0.0s	●	84	0x105
F1.06	Speed tracking stability waiting time	0.00-60.00s	According to model	●	85	0x106
F1.07	Stop mode	0: DEC to stop 1: Free stop	0	●	85	0x107
F1.08	DC braking initial frequency	0.00-50.00Hz	0.00Hz	●	85	0x108
F1.09	DC braking current	0.0-150.0%	0.0%	●	85	0x109
F1.10	DC braking waiting time	0.0-60.0s	0.0s	●	85	0x10A
F1.11	DC braking duration	0.0-60.0s	0.0s	●	85	0x10B
F1.12	Reserved				86	0x10C
F1.13	ACC/DEC mode selection	LED "0" digit: ACC/DEC time base 0: max frequency 1: fixed frequency LED "00" digit: ACC/DEC mode 0: Beeline 1: S Curve LED "000" digit: reserved LED "0000" digit: reserved	0000	○	86	0x10D
F1.14	Start ACC rate of S curve	20.0%-100.0%	50.0%	●	86	0x10E
F1.15	ACC slope increment of S curve	20.0%-100.0%	50.0%	●	86	0x10F
F1.16	Reserved				86	0x110
F1.17	Reserved				86	0x111
F1.18	ACC time 2	0.01-650.00s	10.00s	●	86	0x112
F1.19	DEC time 2	0.01-650.00s	10.00s	●	86	0x113
F1.20	ACC time 3	0.01-650.00s	10.00s	●	86	0x114
F1.21	DEC time 3	0.01-650.00s	10.00s	●	86	0x115
F1.22	ACC time 4	0.01-650.00s	10.00s	●	87	0x116
F1.23	DEC time 4	0.01-650.00s	10.00s	●	87	0x117
F1.24	Emergency stop DEC time	0.01-650.00s	10.0s	●	87	0x118
F1.25	FWD&REV dead time	0.0-120.0s	0.0s	●	87	0x119
F1.26	Min output frequency	0.00-60.00Hz	0.40Hz	●	87	0x11A
F1.27	0 speed hold torque	0.0-150.0%	0.0%	●	88	0x11B
F1.28	0 speed hold torque time	If set between 0.0-5999.9s, 0 speed hold torque keep setting time. If set 6000.0s, 0 speed hold torque no time limit	5.0s	●	88	0x11C
F1.29	Power off restart action selection	0: Invalid 1: Valid	0	●	88	0x11D

F1.30	Power off restart waiting time	0.00-12.00s	0.50s	●	88	0x11E
F1.31	Terminal running protection selection	LED "0" digit: run command selection while electrify 0: Terminal running order invalid while electrify 1: Terminal running order valid while electrify LED "10" digit: while switch the run command given channel 0: invalid 1: valid	0001	●	88	0x11F
F1.32	JOG running frequency setting	0.00-Max frequency	5.00Hz	●	88	0x120
F1.33	JOG ACC time	0.01-650.00s	10.00s	●	88	0x121
F1.34	JOG DEC time	0.01-650.00s	10.00s	●	88	0x122
F1.35	Jump frequency	0.00-Max frequency	0.00Hz	●	89	0x123
F1.36	Jump frequency range	0.00-Max frequency	0.00Hz	●	89	0x124
F1.37	Speed tracking selections	LED"0": way of speed tracking 0.Hardware 1.Software LED"00" direction of speed tracking 0. Search in single direction 1. Search in bi-direction LED"000": Reserved LED"0000": Reserved	0000	●	89	0x125
F1.38	Speed of speed tracking	0.00-1.00%	0.05%	●	89	0x126
F1.39	Voltage restore time	0.10s-10.00s	0.60s	●	89	0x127
F1.40	Speed tracking action current	1.0%-200.0%	According to model	●	89	0x128

**Quantum digital terminal functions**

NO.	Function description	Range of settings and definition	Factory setting	Attribute	Reference page	Communication add
F2.00	Multifunction input terminal 1(X1)	0: No function 1: FWD 2: REV 3: 3-line running control 4: FWD JOG	1	●	90	0x200
F2.01	Multifunction input terminal 2(X2)	5: REV JOG 6: Free stop 7: Emergency stop 8: Malfunction reset 9: Exterior fault input 10: Frequency UP 11: Frequency DW 12: UP/DW clear 13: Run command switch terminal 1 14: Run command switch terminal 2	2	●	90	0x201
F2.02	Multifunction input terminal 3(X3)	15: Multistep terminal1 16: Multistep terminal 2 17: Multistep terminal 3 18: Multistep terminal 4	4	●	90	0x202
F2.03	Multifunction input terminal 4(X4)	19: ACC/DEC time choose terminal 1 20: ACC/DEC time choose terminal 2 21: ACC/DEC pause 22: PID control cancel 23: PID control pause 24: PID characteristic switch	5	●	90	0x203
F2.04	Multifunction input terminal 5(X5)	25: PID given switch 1 26: PID given switch 2 27: PID given switch 3 28: PID feedback switch 1 29: PID feedback switch 2	6	●	90	0x204
F2.05	Multifunction input terminal 6(X6)	30: PID feedback switch 3 31: PLC pause 32: PLC restart 33: Reserved	8	●	90	0x205

F2.06	Multifunction input terminal 7(X7/PUL)	34: Reserved 35: Reserved 36: Frequency channel change terminal 1 37: Frequency channel change terminal 2 38: Frequency channel change terminal 3 39: Frequency channel change terminal 4 40: Timer trigger terminal 41: Timer clear zero terminal 42: Timer clock input terminal 43: Counter clear terminal 44: DC braking order 45: Pre excitation order terminals 46: Speed measuring and counter clear terminal 47: Reserved	0	●	90	0x206
F2.07	Reserved				94	0x208
F2.08	X1-X4 terminal trait selection	LED "0" digit: X1 terminal 0: On valid 1: Off valid LED "00" digit: X2 terminal 0: On valid 1: Off valid LED "000" digit: X3 terminal 0: On valid 1: Off valid LED "0000" digit: X4terminal 0: On valid 1: Off valid	0000	●	94	0x208
F2.09	X1-X4 input terminal filer time	0.000-60.000s	0.010s	●	94	0x209
F2.10	X5-X7 terminal trait selection	LED "0" digit: X5 terminal 0: On valid 1: Off valid LED "00" digit: X6 terminal 0: On valid 1: Off valid LED "000" digit: X7 terminal 0: On valid 1: Off valid LED "0000" digit:reserved	0000	●	94	0x20A
F2.11	X5-X7 input terminal filer time	0.000-60.000s	0.010s	●	94	0x20B

F2.12	Terminal control mode	0: 2-line 1 1: 2-line 2 2: 3-line 1 3: 3-line 2	0	○	95	0x20C
F2.13	Terminal action mode	LED "0" digit: free stop terminal reset mode 0: Reset to original order while invalid 1: Not reset to original order while invalid LED "00" digit: emergency stop terminal reset mode 0: Reset to original order while disconnect 1: Not reset to original order while disconnect LED "000" digit: terminal run mode after fault reset 0: Terminal control to power on directly 1: Terminal control to power on after stop LED "0000" digit: reserved	0111	●	96	0x20D
F2.14	X1-X4 input valid delay	0.00-60.00s	0.00s	●	96	0x20E
F2.15	X5-X7 input valid delay	0.00-60.00s	0.00s	●	96	0x20F
F2.16	PUL input min frequency	0.0-50.00kHz	0.00kHz	●	96	0x210
F2.17	PUL min frequency corresponding setting	0.00-100.00%	0.00%	●	96	0x211
F2.18	PUL input max frequency	0.0-50.00kHz	50.00 kHz	●	96	0x212
F2.19	PUL max frequency corresponding setting	0-100.00%	100.00%	●	96	0x213
F2.20	PUL filter time	0.00s-10.00s	0.10s	●	97	0x214
F2.21	PUL cut-off frequency	0.000-1.000kHz	0.010 kHz	●	97	0x215
F2.22	UP/DW terminal frequency adjust selection	0: Off electricity storage 1: Off electricity does not storage 2: Valid in running, clear zero at stop	0	●	97	0x216
F2.23	UP/DW terminal frequency add/dec speed time	0.01-50.00Hz/s	0.50Hz/s	●	97	0x217
F2.24	Reserved				97	0x218

F2.25	Timer time of unit	0: Second 1: Minute 2: Hour	0	●	97	0x219
F2.26	Timer setting	0-65000	0	●	97	0x21A
F2.27	Counter max value	0-65000	1000	●	98	0x21B
F2.28	Counter setting value	0-65000	500	●	98	0x21C
F2.29	Output terminal (Y)	0: No output 1: Running 2: REV 3.FWD 4: Fault trip alarm 1(alarm while fault self-recover) 5: Fault trip alarm 2(no alarm while fault self-recover) 6: Out fault stop 7: Under voltage 8: Finish ready for running 9: Output frequency level test 1(FDT1) 10: Output frequency level test 2(FDT2) 11: Frequency arrive 12: running at 0 speed 13: Upper frequency limit arrive 14: Lower frequency limit arrive 15: Program running circle period finished 16: Program running step finished 17: PID feedback exceed upper limit 18: PID feedback under lower limit 19: PID feedback sensor wire break 20: Reserved	1	●	98	0x21D
F2.30	Output relay 1 (TA1-TB1-TC1)		2	●	98	0x21E
F2.31	Relay output terminal (TA2-TB2-TC2)	21: Timer time arrive 22: Counter arrive biggest value 23: Counter arrive setting 24: Energy braking 25: PG feedback break 26: Emergency stop 27: Pre alarm output for over load 28: Pre alarm output for under load	4	●	98	0x21F



F2.32	Y and relay output feature	LED "0" digit: Y terminal output 0: low electric level valid 1: high electric level valid LED "00" digit: relay 1 output 0: positive logic 1: negative logic LED "000" digit: relay 2 output 0: positive logic 1: negative logic LED "0000" digit: reserved	0000	●	99	0x220
F2.33	Y output start delay	0.00-60.00s	0.00s	●	100	0x221
F2.34	Y output stop delay	0.00-60.00s	0.00s	●	100	0x222
F2.35	Relay 1 output start delay	0.00-60.00s	0.00s	●	100	0x223
F2.36	Relay 1 output stop delay	0.00-60.00s	0.00s	●	100	0x224
F2.37	Relay 2 output start delay	0.00-60.00s	0.00s	●	100	0x225
F2.38	Relay 2 output stop delay	0.00-60.00s	0.00s	●	100	0x226
F2.39	Output frequency level 1(FDT1)	0.00-300.00Hz	30.00Hz	●	100	0x227
F2.40	FDT1 lag	0.00-300.00Hz	0.00Hz	●	100	0x228
F2.41	Output frequency level 1(FDT2)	0.00-300.00Hz	50.00Hz	●	100	0x229
F2.42	FDT2 lag	0.00-300.00Hz	0.00Hz	●	100	0x22A
F2.43	Given frequency reach detection magnitude	0.00-50.00Hz	0.00Hz	●	100	0x22B
F2.44	Overload pre alarm level	0.0-200.0%	180.0%	●	101	0x22C
F2.45	Overload pre alarm delay	0.0-100.0s	0.5s	●	101	0x22D
F2.46	Under load pre alarm level	0.0-200.0%	30.0%	●	101	0x22E
F2.47	Under load pre alarm delay	0.0-100.0s	0.5s	●	101	0x22F
F2.48	Output frequency level 3	0.00-10.00Hz	2.00Hz	●	101	0x231
F2.49	Output frequency level 4	0.00-10.00Hz	6.00Hz	●	101	0x232

## Extended Terminal Parameter Group

NO.	Function description	Range of settings and definition	Factory setting	Attribute	Reference page	Communicati on add
F2.60	X8-X10 extended terminal feature selection	LED "0" digit: X8 terminal 0: input 1: output LED "00" digit: X9 terminal 0: input 1: output LED "000" digit: X10 terminal 0: input 1: output LED "0000" digit: combination function selection 0: invalid 1: X8,X9 as the pins of CAN	0000	○	102	0x229
F2.61	X11-X13 extended terminal feature selection	LED "0" digit: X11 terminal 0: input 1: output LED "00" digit: X12 terminal 0: input 1: output LED "000" digit: X13 terminal 0: input 1: output LED "0000" digit: combination function selection 0: invalid 1: X11, X12, X13 as the pins of QEP (PG2_A, PG2_B, PG2_Z) 2: X10, X11, X12, X13 SPI	0000	○	102	0x22A
F2.62	X8-X10 extended terminal feature selection	LED "0" digit: X8 terminal 0: on valid 1: off valid LED "00" digit: X9 terminal 0: on valid 1: off valid LED "000" digit: X10 terminal 0: on valid 1: off valid LED "0000" digit:: reserved	0000	○	102	0x22B
F2.63	X11-X13 extended terminal feature selection	LED "0" digit: X11 terminal 0: on valid 1: off valid LED "00" digit: X12 terminal	0000	○	102	0x22C

		0: on valid 1: off valid LED "000" digit: X13 terminal 0: on valid 1: off valid LED "0000" digit: reserved				
F2.64	Multi-function terminal (X8)	Input function selection: Setting range and definition are the same as F2.00 Output function selection: Setting range and definition are the same as F2.29	0	●	103	0x22D
F2.65	Multi-function terminal (X9)		0	●	103	0x22E
F2.66	Multi-function terminal (X10)		0	●	103	0x22F
F2.67	Multi-function terminal (X11)		0	●	103	0x230
F2.68	Multi-function terminal (X12)		0	●	103	0x231
F2.69	Multi-function terminal (X13)		0	●	103	0x232
F2.70	Extended terminal filter time	0.000-0.000s	0.010s	●	103	0x233
F2.71	Extended Y output start delay	0.00-0.00s	0.00s	●	103	
F2.72	Extended Y output stop delay	0.00-0.00s	0.00s	●	103	

### Analog Terminal Parameter Group

NO.	Function description	Range of settings and definition	Factory setting	Attribute	Reference page	Communication add
F3.00	VS Lower limit	0.00-0.00V	0.10V	●	103	0x300
F3.01	VS Lower limit corresponding setting	-100.00-00.00%	0.00%	●	103	0x301
F3.02	VS upper limit	0.00-0.00V	9.90V	●	103	0x302
F3.03	VS upper limit corresponding setting	-100.00-100.00%	100.00%	●	103	0x303
F3.04	VS filter time	0.00-10.00s	0.10s	●	103	0x304
F3.05	VS zero point loop voltage	0.00-10.00V	0.00V	○	103	0x305
F3.06	AI used as VS lower limit	0.00-10.00V	0.10V	●	104	0x306
F3.07	AI lower limit corresponding setting	0.00-100.00%	0.00%	●	104	0x307
F3.08	AI used as VS upper limit	0.00-10.00V	9.90V	●	104	0x308
F3.09	AI upper limit	0.00-100.00%	100.00%	●	104	0x309
F3.10	AI filter time	0.00-10.00s	0.10s	●	104	0x30A
F3.11	AI used as AS lower limit	0.00-20.00mA	4.00mA	●	104	0x310
F3.12	AI used as AS upper limit	0.00-20.00mA	20.00mA	●	104	0x311

F3.13	AS lower limit	0.00-20.00mA	4.00mA	●	104	0x30B
F3.14	AS lower limit	0.00-100.00%	0.00%	●	104	0x30C
F3.15	AS upper limit	0.00-20.00mA	20.00mA	●	104	0x30D
F3.16	AS upper limit corresponding setting	0.00-100.00%	100.00%	●	104	0x30E
F3.17	AS filter time	0.00-10.00s	0.10s	●	104	0x30F
F3.18	Reserved			○	104	0x312
F3.19	Reserved			○	104	0x313
F3.20	Reserved			○	104	0x314
F3.21	Reserved			○	104	0x315
F3.22	A01 output selection	0: Given frequency 1: Output frequency 2: Output current 3: Input voltage 4: Output voltage 5: Machine speed 6: Reserved 7: Output torque 8: PID given value 9: PID feedback value 10: Output power	0	●	104	0x316
F3.23	A02 output selection	11: Bus voltage 12: VS input value 13: AI input value 14: AS input value 15: PUL input value 16: Module temperature 1 17: Module temperature 2	1	●	104	0x317
F3.24	A01 signal selection	0: 0-10V 1: 4.00-20.00mA 2: 0.00-20.00mA	0	●	105	0x318
F3.25	A01 output gain	25.0-200.0%	100.0%	●	105	0x319
F3.26	A01 output signal bias	-100.0-100.0%	0.0%	●	105	0x31A
F3.27	A02 signal selection	0: 0-10V 1: 4.00-20.00mA 2: 0.00-20.00mA 3: FM frequency pulse output 4: Fixed frequency width setting output	0	●	106	0x31B
F3.28	A02 output gain	25.0-200.0%	100.0%	●	107	0x31C
F3.29	A02 analog output signal bias	-100.0%-100.0%	0.0%	●	107	0x31D
F3.30	A02FM frequency output lower limit	0.00-50.00kHz	0.20kHz	●	107	
F3.31	A02FM frequency output upper limit	0.00-100.00kHz	50.00kHz	●	107	0x31E

F3.32	A02 Fixed frequency width setting frequency	0.20-4.00kHz	0.50kHz	●	107	
F3.33	A02 Fixed frequency width setting duty cycle	0.0-100.0%	0.0%	●	107	0x31F

### Keyboard and display parameters

NO.	Function description	Range of settings and definition	Factory setting	Attribute	Reference page	Communication add
F4.00	Parameter and key lock selections	0: Unlock 1: Function parameter lock 2: Function parameter and key lock (except for RUN/STOP/JOG) 3: All function parameter and key lock	0	●	108	0x400
F4.01	User password	0-9999	0	●	108	0x401
F4.02	REV/JOG selections	0: REV 1: JOG	0	●	108	0x402
F4.03	STOP key function range	LED "0" digit: terminal control 0: invalid to terminal order 1: valid to terminal order LED "00" digit: communication control 0: invalid to communication order 1: valid to communication order LED "000" digit: reserved LED "0000" digit: reserved	0100	●	108	0x403
F4.04	UP/DOWN key modification selections	LED "0" digit: keyboard UN/DOWN key modify selection 0: Invalid 1: Modify frequency setting by keyboard numbers(F0.08) 2: Reserved 3: Modify PID give setting by keyboard numbers(Fb.01) 4: Reserved LED "00" digit: keyboard UN/DOWN key store selection 0: No save after power down 1: Save after power down LED "000" digit: reserved LED "0000" digit: reserved	0011	●	108	0x404
F4.05	Function parameter copy	0: No operation 1: Send machine parameters to keyboard and save 2: Send parameters to keyboard and save	0	○	109	0x405

F4.06	Reserved				109	0x406
F4.07	Keyboard potentiometer lowest limit	0.00V-5.00V	0.50V	●	109	0x407
F4.08	Keyboard potentiometer lowest limit corresponding setting	0-100.00%	0.00%	●	109	0x408
F4.09	Keyboard potentiometer upper limit	0.00V-5.00V	4.50V	●	109	0x409
F4.10	Keyboard potentiometer upper limit corresponding setting	0-100.00%	100.00%	●	109	0x40A
F4.11	The display content of the first line at the running state	LED*0"digit: display the first group 0: Given frequency 1: Output frequency 2: Output current 3: Input voltage 4: Output voltage 5: Machine speed 6: Reserved 7: Output torque 8: PID given value 9: PID feedback value A: Output power B: Bus voltage C: Module temperature 1 D: Module temperature 2 E: ON/OFF state of input terminal X F: ON/OFF state of input terminal Y LED*10"digit: display the second group LED*100"digit: display the third group LED*1000" digit: display the fourth group	3210	●	110	0x40B
F4.12	The display content of the first line at the stopped state	LED "0" digit: display the first group LED*00"digit:display the second group LED*000" digit: display the third group LED*0000"digit:display the fourth group	3210	●	110	0x40C
F4.13	The display content of the second line at the running state	LED "0" digit: display the first group LED*00"digit:display the second group LED*000" digit: display the third group LED*0000"digit:display the fourth group	3210	●	110	0x40D

F4.14	The display content of the second line at the stopped state	LED "0" digit: display the first group LED"00"digit:display the second group LED"000" digit: display the third group LED"0000"digit:display the fourth group	3210H	●	110	0x40E
F4.15	Rotate speed display coefficient	0.0-5000.0%	100.0%	●	110	0x40F
F4.16	Keyboard display selection	LED "0" digit: LED display language 0: Chinese 1: English LED"00" digit: output frequency selection 0: Aim frequency 1: Actual frequency LED"000"digit: machine speed display selection 0: Aim speed 1: Actual speed LED"0000" digit: reserved	0000	●	110	0x410

### Motor parameters

NO.	Function description	Range of settings and definition	Factory setting	Attribute	Reference page	Communication add
F5.00	Reserved			○	111	0x500
F5.01	Number of motor poles	2-48	4	○	111	0x501
F5.02	Motor rated power	0.4-1000.0KW	According to model	○	111	0x502
F5.03	Motor rated frequency	0.01Hz-max frequency	According to model	○	111	0x503
F5.04	Motor rated speed	0-65000rpm	According to model	○	111	0x504
F5.05	Motor rated voltage	0-1500V	According to model	○	111	0x505
F5.06	Motor rated current	0.1-2000.0A	According to model	○	111	0x506
F5.07	Motor no-load current	0.01-650.00A	According to model	●	111	0x507
F5.08	Motor stator resistance	0.001-65.000	According to model	●	111	0x508
F5.09	Motor rotor resistance	0.001-65.000	According to model	●	111	0x509
F5.10	Motor stator & rotor inductance	0.1-6500.0mH	According to model	●	111	0x50A
F5.11	Motor stator & rotor mutual inductance	0.1-6500.0mH	According to model	●	112	0x50C

F5.12	Motor parameters self-adjustment selections	0: No operation 1: Rotary type self-study 2: Resting type self-study	0	○	112	0x50D
F5.13	Motor coefficient 1	0-2048	According to model	●	112	0x50D
F5.14	Motor coefficient 2	1-10000	According to model	●	112	0x50E
F5.15	Motor coefficient 3	1-10000	According to model	●	112	0x50F
F5.16	Motor coefficient 4	1-10000	According to model	●	112	0x510
F5.17	Reserved				112	0x511
F5.18	Reserved				112	0x512
F5.19	Reserved				112	0x513
F5.20	PG selection	LED "0" digit: input selection 0: single input 1: double input LED"00" digit: input phase regulation 0: same direction 1: reverse direction LED"000" digit: PG break wire detection 0: invalid 1: valid LED"0000" digit: reserved	0001	○	112	0x514
F5.21	PG pulse per week	1-0000	1024	○	112	0x515
F5.22	PG break wire detection time	0.100-30.000s	2.000s	●	112	0x516
F5.23	Extended PG selection	LED "0" digit: extended PG input selection 0: single input 1: double input LED"00" digit: extended PG input phase regulation 0: same direction 1: reverse direction LED"000" digit: extended PG break wire detection 0: invalid 1: valid LED"0000" digit: reserved	0001	○	113	0x517
F5.24	Extended PG pulse per week	1-60000	1024	○	113	0x518
F5.25	Extended PG break wire detection time	0.100-30.000s	2.000s	●	113	0x519



F5.26	Reserved				113	0x51A
F5.27	Reserved				113	0x51B
F5.28	Speed measuring and counter selection	<p>LED "0" digit: hardware speed measuring channel selection channel 0: PG 1: PUL port 2: Extended PG</p> <p>LED"00" digit: counter selection 0: PG 1: PUL port 2: Extended PG</p> <p>LED"000"digit: counter direction 0: Fwd counting 1: Rev counting</p> <p>LED"0000" digit: PG and extended PG counter clear 0: count to the counter zero clear setting value (5.29+F5.30×65536) 1: signal valid clear zero</p>	0020	○	113	0x51C
F5.29	PG and extended PG counter clear lower	0-65535	65535	●	113	0x51D
F5.30	PG and extended PG counter clear upper	0-65535	65535	●	113	0x51E
F5.31	PUL counter frequency-dividing	0-31	0	●	113	0x51F

**VC control parameter**

NO.	Function description	Range of settings and definition	Factory setting	Attribute	Reference page	Communication add
F6.00	ASR proportional gain 1	0.00-2.00	According to model	●	114	0x600
F6.01	ASR integral time 1	0.01-10.00s	According to model	●	114	0x601
F6.02	ASR differential time 1	0.0-100.0	0.0	●	114	0x602
F6.03	ASR filter time1	0.000-0.100s	0.020s	●	114	0x603
F6.04	ASR switch frequency 1	0.0Hz-50.0Hz	5.00Hz	●	114	0x604
F6.05	ASR proportional gain 2	0.00-1.00	According to model	●	114	0x605
F6.06	ASR integral time 2	0.01-10.00s	According to model	●	114	0x606
F6.07	ASR differential time	0.0-100.0s	0.0s	●	114	0x607
F6.08	ASR filter time 2	0.000-0.100s	0.020s	●	114	0x608

F6.09	ASR switch frequency 2	0.00-50.00Hz	10.00Hz	●	114	0x609
F6.10	VC slip coefficient	0-250%	100%	●	115	0x60A
F6.11	Max output torque	20.0-250.0%	165.0%	●	115	0x60B
F6.12	Constant power area torque compensation start frequency	100.0%-500.0%	120.0%	●	115	0x60C
F6.13	Constant power area torque compensation coefficient	0-100%	30%	●	115	0x60D
F6.14	Reserved				115	0x60E
F6.15	Reserved				115	0x60F
F6.16	Reserved				115	0x610
F6.17	Reserved				115	0x611
F6.18	Reserved				115	0x612
F6.19	Reserved				115	0x613
F6.20	Vector ACR proportional gain	0.01-5.00	According to model	●	115	0x614
F6.21	Vector ACR integral time	0.01-0.00	According to model	●	115	0x615
F6.22	Vector CR filter coefficient	0.01-0.00	According to model	●	115	0x616
F6.23	Reserved				115	0x617

**V/F control parameters**

NO	Function description	Range of settings and definition	Factory setting	Attribute	Reference page	Communication add
F8.00	V/F curve selection	0: Beeline 1: User-defined V/F curve 2: 1.3 power falling torque curve 3: 1.7 power falling torque curve 4: 2.0 power falling torque curve	0	○	116	0x800
F8.01	Self-setting voltage V1	0.0%-100.0%	3.0%	○	116	0x801
F8.02	Self-setting frequency F1	0.00-max frequency	1.00Hz	○	116	0x802
F8.03	Self-setting voltage V2	0.0%-100.0%	28.0%	○	116	0x803
F8.04	Self-setting frequency F2	0.00-max frequency	10.00Hz	○	116	0x804
F8.05	Self-setting voltage V3	0.0%-100.0%	55.0%	○	116	0x805
F8.06	Self-setting frequency F3	0.00-max frequency	25.00Hz	○	116	0x806

F8.07	Self-setting voltage V4	0.0%-100.0%	78.0%	○	116	0x807
F8.08	Self-setting frequency F4	0.00-max frequency	37.50Hz	○	116	0x808
F8.09	Self-setting voltage V5	0.0%-100.0%	100.0%	○	116	0x809
F8.10	Self-setting frequency F5	0.00-max frequency	50.00Hz	○	116	0x80A
F8.11	Output voltage percentage	25.0-120.0%	100.0%	○	117	0x80B
F8.12	Torque boost	0.1%-30.0%	According to model	○	117	0x80C
F8.13	Torque boost close	0.0%-100.0%	50.0%	○	117	0x80D
F8.14	V/F slip compensation	0.0-200.0%	0.0%	●	118	0x80E
F8.15	Auto energy-saving selection	0: no auto energy-saving 1: auto energy-saving	0	●	118	0x80F
F8.16	Lower frequency limit of energy-saving operation	0.0-500.0%	20.0%	●	118	0x810
F8.17	Energy-saving voltage down time	0.01-50.00s	10.00s	●	118	0x811
F8.18	Energy-saving voltage lowest limit	20.0-100.0%	50.0%	●	118	0x812
F8.19	Voltage fall recovery time	0.01-50.00s	According to model	●	118	0x813
F8.20	ASR(VF) proportion gain1	0.00-50.00	1.00	●	118	0x814
F8.21	ASR(VF) integral time 1	0.000-1.000s	0.010s	●	118	0x815
F8.22	ASR(VF) filter time1	0.000-1.000s	0.010s	●	119	0x816
F8.23	ASR(VF) switch frequency 1	0.00-50.00Hz	5.00Hz	●	119	0x817
F8.24	ASR(VF) proportion gain 2	0.0-50.00	0.10	●	119	0x818
F8.25	ASR(VF) integral time 2	0.000-1.000s	0.020s	●	119	0x819
F8.26	ASR(VF) filter time 2	0.000-1.000s	0.010s	●	119	0x81A
F8.27	ASR(VF) switch frequency 2	0.00-50.00Hz	10.00Hz	●	119	0x81B
F8.28	ASR(VF) adjustment upper limit frequency	0.00-20.00Hz	5.00Hz	●	119	0x81C
F8.29	Reserved				120	0x81D

**Malfunction and protection parameters**

NO.	Function description	Range of settings and definition	Factory setting	Attribute	Reference page	Communication add
FA.00	Protection function selection 1	<p>LED "0" digit: ACC over-current protection selection 0: Invalid 1: Valid</p> <p>LED "00" digit: DEC over-current protection selection 0: Invalid 1: Valid</p> <p>LED "000" digit: current limit selection while running 0: Invalid 1: Valid</p> <p>LED "0000" digit: current limit by control wave 0: Invalid 1: Valid</p>	1101	●	120	0xA00
FA.01	Protection function selection 2	<p>LED "0" digit: DEC over-voltage protection selection 0: Invalid 1: rating 1 over-voltage protection 2: rating 2 over-voltage protection</p> <p>LED "00" digit: RUN over-voltage protection selection 0: Invalid 1: Valid</p> <p>LED "000" digit: inverter over-load action selection 0: emergency stop output and alarm 1: emergency stop and alarm 2: limit current and run</p> <p>LED "0000" digit: motor over-load act 0: emergency stop output and alarm 1: emergency stop and alarm 2: limit current and run 3: motor over-load protection off</p>	0001	●	121	0xA01

FA.02	Protection function selection 3	LED "0"digit: motor overload protection mode 0: motor overload curve 1: setting overload point protection LED"00"digit: input phase lack protection selection 0: Invalid 1: Valid LED"000"digit: output phase lack protection selection 0: Invalid 1: Valid LED"0000"digit: reserved	0110	●	122	0xA02
FA.03	Protection function selection 4	LED "0"digit: SC protection selection 0: Invalid 1: Valid LED"00"digit: OC protection selection 0: Invalid 1: Valid LED"000"digit: reserved LED"0000"digit: reserved	1100	●	122	0xA03
FA.04	Protection function selection 5	LED "0"digit: reserved LED"00"digit: reserved LED"000"digit: reserved LED"0000"digit: reserved	0000	●	122	0xA04
FA.05	Fan control	0: Fan run after electrify 1: Fan stop related to temperature 2: Fan stop while machine stop, run related to temperature	1	●	122	0xA05
FA.06	Bus under voltage protection value	50.0-100.0%	60.0%	●	123	0xA06
FA.07	Energy braking action voltage	115.0-150.0%	According to model	●	123	0xA07
FA.08	Deceleration OV suppression point	110-150%	According to model		123	0xA08
FA.09	Acceleration and constant speed OV suppression point	100.0-150.0%	120.0%	●	123	0xA09
FA.10	Acceleration and constant speed OV suppression plus frequency max amplitude	0.00-20.00Hz	2.00Hz	○	123	0xA0A

FA.11	Acceleration and constant speed OV suppression response gain	0.00-10.00	0.50	●	124	0xA0B
FA.12	Acceleration and constant speed OV suppression integral time	0.00-10.00s	0.00s	●	124	0xA0C
FA.13	Reserved				124	0xA0D
FA.14	Reserved				124	0xA0E
FA.15	Fault self recovery times	0-5	0	●	124	0xA0F
FA.16	Fault self recovery interval	0.1-100.0s	1.0s	●	124	0xA10
FA.17	Instant loss power deceleration action voltage threshold value	0-00%	70%	●	125	0xA11
FA.18	Reserved				125	0xA12
FA.19	Instant loss power deceleration gain	0.00-50.00	0.00	●	125	0xA13
FA.20	Reserved				125	0xA14
FA.21	Reserved				125	0xA15
FA.22	Current surge suppression gain	0.0-500.0%	100.0%	●	125	0xA16
FA.23	Deceleration time when wave by wave current limit	0.01-300.00s	2.00s		125	0xA17
FA.24	Motor overload protection coefficient	20.0-250.0%	100.0%		125	0xA18
FA.25	Acceleration OC suppression point	100-250%	160%	●	126	0xA19
FA.26	Deceleration OC suppression point	100-250%	160%	●	126	0xA1A
FA.27	Running constant torque area current limit point	100-250%	160%	●	126	0xA1B
FA.28	Running constant power area current amplitude limit coefficient	20-200%	100%	●	126	0xA1C
FA.29	Current amplitude limit frequency ACC/DEC time	0.01-300.00s	0.50s	●	126	0xA1D

FA.30	Current amplitude limit PI gain coefficient	0-20000	According to model	●	126	0xA1E
FA.31	Current amplitude limit PI integral coefficient	0-20000	According to model		126	0xA1F
FA.32	Reserved				126	0xA20
FA.33	Reserved				126	0xA21
FA.34	Fault inle phase current instant max value	0.1-2000.0A	--	×	126	0xA22
FA.35	Fault type	See fault code list	--	×	126	0xA23
FA.36	Fault running frequency	0.00-ax frequency	--	×	126	0xA24
FA.37	Fault output voltage	0-1500V	--	×	126	0xA25
FA.38	Fault output current	0.1-2000.0A	--	×	126	0xA26
FA.39	Fault bus voltage	0-3000V	--	×	126	0xA27
FA.40	Fault module temperature	0-100℃	--	×	126	0xA28
FA.41	Fault inverter status	LED "0"digit: run direction 0: FWD 1: REV LED"00"digit: run status 0: stop 1: steady speed 2: ACC 3: DEC LED"000"digit: process status 1: parameter identifying 2: jogging 3: current limit wave by wave LED"0000"digit: output loss phase status 0: loss phase 1: loss phase 2: loss phase 3: W loss phase	--	×	127	0xA29
FA.42	Fault input terminal status	See input terminal status diagram	--	×	127	0xA2A
FA.43	Fault output terminal status	See output terminal status diagram	--	×	127	0xA2B
FA.44	The last malfunction types	Please see malfunction code table	--	×	127	0xA2C

FA.45	The last malfunction running frequency	0.00-max frequency	--	×	127	0xA2D
FA.46	The last malfunction output	0-1500V	--	×	127	0xA2E
FA.47	The last malfunction output	0.1-2000.0A	--	×	127	0xA2F
FA.48	The last malfunction bus	0-3000V	--	×	127	0xA30
FA.49	The last malfunction module	0-100°C	--	×	127	0xA31
FA.50	The last malfunction machine state	Same as [FA.41]	--	×	127	0xA32
FA.51	The last malfunction input terminal state	See input terminal chart	--	×	127	0xA33
FA.52	The last malfunction output terminal state	See input terminal chart	--	×	127	0xA34
FA.53	The first two malfunction types	Please see malfunction code table	--	×	127	0xA35
FA.54	The first three malfunction types	Please see malfunction code table	--	×	127	0xA36

**PID process control parameters**

NO.	Function description	Range of settings and definition	Factory setting	Attribute	Reference page	Communication add
Fb.00	PID given signal source	0: Keyboard number giving PID 1: Keyboard potentiometer 2: Terminal VS voltage analog 3: Terminal AI analog 4: Terminal AS current analog 5: Terminal PUL pulse signal 6: RS485 communication 7: Optional card 8: Terminal selection	0	○	130	0xB00
Fb.01	Keyboard digit given PID	0.00-100.0	50.0%	●	130	0xB01
Fb.02	PID feedback signal source	0: Keyboard digit PID given 1: Keyboard potentiometer given 2: Terminal VS voltage analog given 3: Terminal AI analog given 4: Terminal AS current analog given 5: Terminal PUL pulse signal given 6: RS485 communication given 7: Optional card 8: Terminal selection	2	○	130	0xB02
Fb.03	Feedback signal gain	0.00-10.00	1.00	●	131	0XB03



Fb.04	Feedback signal max measuring range	0-100.0	100.0	●	131	0xB04
Fb.05	PID control selection	LED "0" digit: feedback trait selection 0: Positive trait 1: Negative trait LED "10" digit: PID adjust direction selection 0: reverse forbidden 1: reverse allowed LED "100" digit: error of center-aligned selection 0: not centre align 1: centre align LED "1000" digit: reserved	0100	○	131	0xB05
Fb.06	PID preset frequency	0.00-Max frequency	50.00Hz	●	132	0xB06
Fb.07	PID preset frequency running time	0.0-6500.0s	0.0s	●	132	0xB07
Fb.08	Proportion gain P1	0.00-100.00	1.00	●	133	0xB08
Fb.09	Integral time I1	0.01-10.00s	0.10s	●	133	0xB09
Fb.10	Differential coefficient D1	0.00-10.00s	0.00s	●	133	0xB0A
Fb.11	Sample cycle	0.01-100.00s	0.10s	●	133	0xB0B
Fb.12	PID control deviation limitation	0.0-100.0%	0.0%	●	133	0xB0C
Fb.13	Reserved				133	0xB0D
Fb.14	Detection time while feedback wire break	0.0~120.0s	1.0s	●	134	0xB0E
Fb.15	Action selections while feedback wire break	0: Go on PID operation without alarm 1: Stop and alarm malfunction 2: Go on PID operation and output alarm signal 3: Run at the current frequency and output alarm signal	0	●	134	0xB0F
Fb.16	Wire break alarm upper limit	0.0-100.0%	100.0%	●	134	0xB10
Fb.17	Wire break alarm lower limit	0.0-100.0%	0.0%	●	134	0xB11
Fb.18	Constant pressure water supply sleep system selection	0: Invalid 1: Valid	0	●	134	0xB12
Fb.19	Start-up threshold	0.0-100.0%	0.0%	●	134	0xB13
Fb.20	Dormancy threshold	0.0-100.0%	0.900	●	134	0xB14
Fb.21	Dormancy sense DEC time	0-6500.0s	30.0s	●	134	0xB15

Fb.22	Stop sense low bit hold frequency	0-20.00Hz	10.00Hz	●	134	0xB16
-------	-----------------------------------	-----------	---------	---	-----	-------

**Multi-step, PLC function and swing frequency parameters**

NO.	Function description	Range of settings and definition	Factory setting	Attribute	Reference page	Communication add
FC.00	PLC Step 1	0.00-320.00Hz	10.00Hz	●	135	0xC00
FC.01	PLC Step 2	0.00-320.00Hz	20.00Hz	●	135	0xC01
FC.02	PLC Step 3	0.00-320.00Hz	30.00Hz	●	135	0xC02
FC.03	PLC Step 4	0.00-320.00Hz	40.00Hz	●	135	0xC03
FC.04	PLC Step 5	0.00-320.00Hz	50.00Hz	●	135	0xC04
FC.05	PLC Step 6	0.00-320.00Hz	40.00Hz	●	135	0xC05
FC.06	PLC Step 7	0.00-320.00Hz	30.00Hz	●	135	0xC06
FC.07	PLC Step 8	0.00-320.00Hz	20.00Hz	●	135	0xC07
FC.08	PLC Step 9	0.00-320.00Hz	10.00Hz	●	135	0xC08
FC.09	PLC Step 10	0.00-320.00Hz	20.00.H	●	135	0xC09
FC.10	PLC Step 11	0.00-320.00Hz	30.00Hz	●	135	0xC0A
FC.11	PLC Step 12	0.00-320.00Hz	40.00Hz	●	135	0xC0B
FC.12	PLC Step 13	0.00-320.00Hz	50.00Hz	●	135	0xC0C
FC.13	PLC Step 14	0.00-320.00Hz	40.00Hz	●	135	0xC0D
FC.14	PLC Step 15	0.00-320.00Hz	30.00Hz	●	135	0xC0E
FC.15	PLC running Mode selection	LED*0*digit: 0: Stop after single cycle 1: Continuous cycles 2: Keep final value after single cycle LED*10*digit: Time unit 0: second 1: minute 2: hour LED*100*digit: Power down memory mode 0: no saved 1: save LED*1000*digit: Start-up mode 0: Restart from the 1 <sup>st</sup> step 1: Restart from the stop stage 2: Continue from the time when stop LED*0000*digit: Start-up mode 0: Restart from the 1 <sup>st</sup> step 1: Restart from the step where stop 2: Restart from the time when stop	0000	●	136	0xC0F

FC.16	PLC 1st step running time	0.0-6500.0(s/m/h)	10.0	●	137	0xC10
FC.17	PLC 2nd step running time	0.0-6500.0(s/m/h)	10.0	●	137	0xC11
FC.18	PLC 3rd step running time	0.0-6500.0(s/m/h)	10.0	●	138	0xC12
FC.19	PLC 4th step running time	0.0-6500.0(s/m/h)	10.0	●	138	0xC13
FC.20	PLC 5th step running time	0.0-6500.0(s/m/h)	10.0	●	138	0xC14
FC.21	PLC 6th step running time	0.0-6500.0(s/m/h)	10.0	●	138	0xC15
FC.22	PLC 7th step running time	0.0-6500.0(s/m/h)	10.0	●	138	0xC16
FC.23	PLC 8th step running time	0.0-6500.0(s/m/h)	10.0	●	138	0xC17
FC.24	PLC 9th step running time	0.0-6500.0(s/m/h)	10.0	●	138	0xC18
FC.25	PLC 10th step running time	0.0-6500.0(s/m/h)	10.0	●	138	0xC19
FC.26	PLC 11th step running time	0.0-6500.0(s/m/h)	10.0	●	138	0xC1A
FC.27	PLC 12th step running time	0.0-6500.0(s/m/h)	10.0	●	138	0xC1B
FC.28	PLC 13th step running time	0.0-6500.0(s/m/h)	10.0	●	138	0xC1C
FC.29	PLC 14th step running time	0.0-6500.0(s/m/h)	10.0	●	138	0xC1D
FC.30	PLC 15th step running time	0.0-6500.0(s/m/h)	10.0	●	138	0xC1E
FC.31	PLC 1st step direction and ADD/DEC time	LED "0" digit: this step run direction 0: FWD 1: REV LED "00" digit: ACC/DEC time in this step 0: ACC/DEC time 1 1: ACC/DEC time 2 2: ACC/DEC time 3 4: ACC/DEC time 4 LED "000" digit: reserved LED "0000" digit: reserved	0000	●	138	0xC1F
FC.32	PLC 2nd step direction and ADD/DEC time		0000	●	138	0xC20
FC.33	PLC 3rd step direction and ADD/DEC time		0000	●	138	0xC21
FC.34	PLC 4th step direction and ADD/DEC time		0000	●	138	0xC22
FC.35	PLC 5th step direction and ADD/DEC time		0000	●	138	0xC23
FC.36	PLC 6th step direction and ADD/DEC time		0000	●	138	0xC24
FC.37	PLC 7th step direction and ADD/DEC time		0000	●	138	0xC25
FC.38	PLC 8th step direction and ADD/DEC time		0000	●	138	0xC26

FC.39	PLC 9 <sup>th</sup> step direction and ADD/DEC time		0000	●	138	0xC27
FC.40	PLC 10 <sup>th</sup> step direction and ADD/DEC time		0000	●	138	0xC28
FC.41	PLC 11 <sup>th</sup> step direction and ADD/DEC time		0000	●	138	0xC29
FC.42	PLC 12 <sup>th</sup> step direction and ADD/DEC time		0000	●	138	0xC2A
FC.43	PLC 13 <sup>th</sup> step direction and ADD/DEC time		0000	●	138	0xC2B
FC.44	PLC 14 <sup>th</sup> step direction and ADD/DEC time		0000	●	138	0xC2C
FC.45	PLC 15 <sup>th</sup> step direction and ADD/DEC time		0000	●	138	0xC2D
FC.46	Reserved				138	0xC2E
FC.47	Reserved				138	0xC2F
FC.48	Reserved				138	0xC30
FC.49	Reserved				138	0xC31
FC.50	Reserved				138	0xC32
FC.51	Reserved				138	0xC33
FC.52	Reserved				138	0xC34

### Communication control function parameters

NO.	Function description	Range of settings and definition	Factory setting	Attribute	Reference page	Communication add
Fd.00	Main-slave machine selection	0: Main machine 1: Slave machine	0	○	139	0xD00
Fd.01	Machine add	1-247	1	○	139	0xD01
Fd.02	Communication baud rate selection	0: 1200 bps 1: 2400 bps 2: 4800 bps 3: 9600 bps 4: 19200 bps 5: 38400 bps	3	○	139	0xD02

Fd.03	Data format	<p>0: (N,8,1) no checkout, Data digit: 8, Stop digit: 1</p> <p>1: (E,8,1) even checkout, Data digit: 8, Stop digit: 1</p> <p>2: (O,8,1) odd checkout, Data digit: 8, Stop digit: 1</p> <p>3: (N,8,2) no checkout, Data digit: 8, Stop digit: 2</p> <p>4: (E,8,2) even checkout, Data digit: 8, Stop digit: 2</p> <p>5: (O,8,2) odd checkout, Data digit: 8, Stop digit: 2</p>	0	○	139	0xD03
Fd.04	Communication ratio setting	0.00-5.00	1.00	●	139	0xD04
Fd.05	Communication answer delay	0-500ms	0ms	●	139	0xD05
Fd.06	Communication overtime time	0.1-100.0s	1.0s	●	140	0xD06
Fd.07	RS485 communication fault action mode selection	<p>0: Alarm and stop freely</p> <p>1: Not alarm, go on run</p> <p>2: Stop without alarm</p> <p>3: Stop without alarm ( running gived by channels)</p>	1	●	140	0xD07
Fd.08	Transmission response dispose	<p>0: Write operation with response</p> <p>1: Write operation without response</p>	0	●	140	0xD08
Fd.09	Main machine sending selection	<p>LED"0"digit: the first group of transmit frame selection</p> <p>0: Invalid</p> <p>1: Run command given</p> <p>2: Main machine given</p> <p>3: Main machine output frequency</p> <p>4: Main machine upper limit frequency</p> <p>5: Main machine given torque</p> <p>6: Main machine output torque</p> <p>7: Reserved</p> <p>8: Reserved</p> <p>9: Main machine given PID</p> <p>A: Main machine feedback PID</p> <p>LED"10"digit: the second group of transmit frame selection Ditto</p> <p>LED"100"digit: the third group of transmit frame selection Ditto</p> <p>LED"1000"digit: the fourth group of transmit frame selection Ditto</p>	0031	●	140	0xD09

Fd.10	Reserved				140	0xD0A
Fd.11	Reserved				140	0xD0B
Fd.12	Reserved				140	0xD0C

**Monitor code**

NO.	Function name	Range of settings and definition	Communication add
C-00	Given frequency	0.01Hz	2100H
C-01	Output frequency	0.01Hz	2101H
C-02	Output current	0.1A	2102H
C-03	Input voltage	0.1V	2103H
C-04	Output voltage	0.1V	2104H
C-05	Machine speed	RPM	2105H
C-06	Set torque	0.1%	2106H
C-07	Output torque	0.1%	2107H
C-08	PID given	0.1%	2108H
C-09	PID feedback	0.1%	2109H
C-10	Reserved	-	210AH
C-11	Bus voltage	0.1V	210BH
C-12	Module temperature 1	0.1℃	210CH
C-13	Module temperature 2	0.1℃	210DH
C-14	Input terminal X on-state	refer to diagram x	210EH
C-15	Output terminal Y on-state	refer to diagram x	210FH
C-16	Analog VS input	0.001V	2110H
C-17	Analog AI input	0.001V	2111H
C-18	Analog AS input	0.001mA	2112H
C-19	Impulse single PUL input	0.001kHz	2113H
C-20	Analog output AO1	0.01V	2114H
C-21	Analog output AO2	0.01V/0.01mA/0.01kHz	2115H
C-22	Counting value of counter		2116H
C-23	Running time after electrify(of this time)	Hour	2117H
C-24	Local accumulative running time	0.1h	2118H
C-25	Inverter power class	kW	2119H
C-26	Inverter rated voltage	V	211AH
C-27	Inverter rated current	A	211BH
C-28	Software edition		211CH

C-29	PG feedback frequency	0.01Hz	211DH
C-30	Extended input terminals state		211EH
C-31	Extended output terminals state		211FH
C-32	Reserved		2120H
C-33	PG, PUL ports counting value lower 16 digits	0-65535	2121H
C-34	PG, PUL ports counting value lower 16 digits	0-65535	2122H
C-35	Output active power	0.1KW	2123H
C-36	Output reactive power	0.1KVA	2124H
C-37	Current running electricity	0.1KWH	2125H
C-38	Controller software version	0.00	2126H
C-39	Reserved		2127H
C-40	Reserved		2128H

#### Input terminal on/off show diagram:

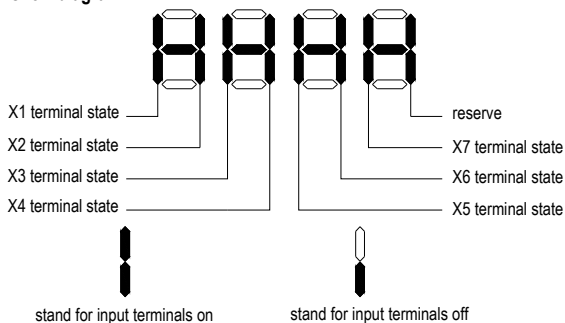

#### Output terminal on/off show diagram:

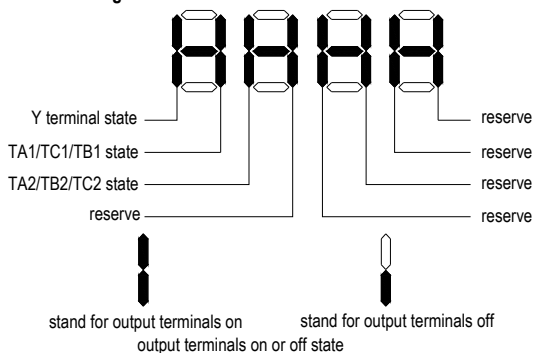

## 10.2 Appendix 2: RS485 communication protocol

### ● Communication protocol

The AC80C series frequency inverter can select the RS485 communication interface. The ModBus communication protocol of international standard is adopted for master-slave communication. The consumer can carry out centralized control by PC/PLC, upper machine, mAC80Cn station frequency inverter etc (Setting of the frequency inverter control command, running frequency, relative function parameters modification, frequency inverter working state and malfunction information monitoring etc.) to adapt to the special application requirements.

### ● Application styles

1. AC80C series frequency inverter is connected to "single host and many slave machines" control network with RS232/RS485 master line. Slave machine do not response while mAC80Cn machine order with broadcast (while slave machine add is 0).
2. AC80C afford RS485 port only, asynchronous half-duplex. While the communication port of the external equipment is RS232, RS232/RS485 converter should be added.
3. This ModBus serial communication protocol defines asynchronous transfer information content and formats used in the serial communication, which can be divided into RUT and ASCII mode. AC80 is RTU (remote terminal unit) mode.

### ● Communication frame structure

Communication data format is as follows:

The byte composition: Include initiation bit, 8 data bit, check bit and stop bit.

initiation bit	Bit1	Bit2	Bit3	Bit4	Bit5	Bit6	Bit7	Bit8	check bit	stop bit
----------------	------	------	------	------	------	------	------	------	-----------	----------

One frame message must be transmitted as a continued data flow, if there is a pause over 1.5 byte before the end. The receiving equipment will clear the half-baked information. And the next byte will be considered as the address domAC80Cn of a new frame. Similarly, if the interval between a new frame start-up and the former frame is smaller than 3.5 byte time, the receiving equipment will think that it is the former one frame continuation. Because of the jumbled frame, finally CRC checking value is incorrect, what leads to the communication mistake.

### RTU frame's standard structure:

Frame START	Transmission time of 3.5 bytes
Slave machine address	Communication address: 0~247(decimal)(0 is broadcast address)
Function code	03H: read slave machine parameter 06H: write slave machine parameter 08H: circuit auto-detection
Data domAC80Cn	parameter address, parameter number, parameter values
CRC CHK low-order	Detecting value: 16 bit CRC Detecting value
CRC CHK high-order	
Frame ending	transmission time of 3.5 bytes

In RTU mode, it always begins with transmission time pause gap of at least 3.5 bytes. The successive order of the following transmission data domAC80Cns: slave machine address, operation command code、 data and CRC checking bit. Transmission byte of each domAC80Cn is hexadecimal 0...9, A...F. Network equipment detects the network bus unceasingly, including the pause gap time. While receiving the first domAC80Cn (address information), each network equipment carries out decoding to judge whether the byte is sent to it. While the final byte transmission is completed, there will be an at least 3.5 bytes transmission time pause gap to indicate that this frame is over. Then a new information' transmission can begin.



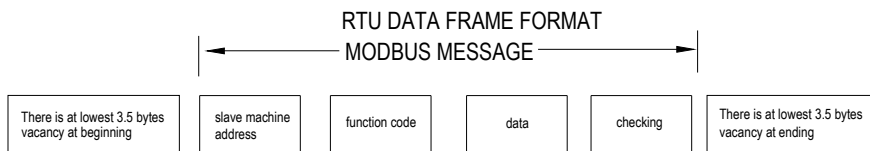

### ● Command code and communication data description

For example: The frequency inverter whose slave machine address is 01 H, memory initial address is 2100H [(C-00)], read continuously 3 words, then the structure of that frame is described as follows:

#### RTU host machine command information

START	Transmission time of 3.5 bytes
Slave machine address	01H
Command code	03H
Start address high-order	21H
Start address low-order	00H
Data number high-order	00H
Data number low-order	03H
CRC CHK low-order	0FH
CRC CHK high-order	F7H
END	Transmission time of 3.5 bytes

#### RTU Slave machine responding information (normal)

START	Transmission time of 3.5 bytes
Slave machine address	01H
Command code	03H
Byte number low-order	06H
Data address 2100H high-order	13H
Data address 2100H low-order	88H
Data address 2101H high-order	00H
Data address 2101H low-order	00H
Data address 2102H high-order	00H
Data address 21021H low-order	00H
CRC CHK low-order	90H
CRC CHK high-order	A6H
END	Transmission time of 3.5 bytes

#### Slave machine responding information (abnormal)

START	Transmission time of 3.5 bytes
Slave machine address	01H
Command code	03H
Error code	04H
CRC CHK low-order	21H
CRC CHK high-order	33H
END	Transmission time of 3.5 bytes

Command code: 06H, write a word (Word)

Function: write a word data in the designated data address. It can be used to revise the frequency inverter parameters.

For instance: 5000 (1388 H) is written into the 3000H address of slave frequency inverter with address 1. Then the structure of this frame is described as follows:

#### RTU host machine order information

START	Transmission time of 3.5 bytes
Slave machine address	01H
Command code	06H
Write data address high-order	30H
Write data address low-order	00H
Data content high-order	13H
Data content low-order	88H
CRC CHK low-order	8BH
CRC CHK high-order	9CH
EBD	Transmission time of 3.5 bytes

#### RTU Slave machine responding information (normal)

START	Transmission time of 3.5 bytes
Slave machine address	01H
Command code	06H
Write data address high-order	30H
Write data address low-order	00H
Data content high-order	13H
Data content low-order	88H
CRC CHK low-order	8BH
CRC CHK high-order	9CH
EBD	Transmission time of 3.5 bytes

#### RTU Slave machine responding information (abnormal)

START	Transmission time of 3.5 bytes
Slave machine address	01H
Command code	86H
Error code	01H
CRC CHK low-order	83H
CRC CHK high-order	A0H
END	Transmission time of 3.5 bytes

Command code: 08H, circuit auto-detection

Function: Send back the slave machine responding information which is identical with the host machine command information. It is used to check whether the signal transmission between the host machine and slave machine is regular or not. The checking code and the data can be set freely.

**TU Host machine command information**

START	Transmission time of 3.5 bytes
Slave machine address	01H
Command code	08H
Detecting code high-order	00H
Detecting code low-order	00H
Data high-order	13H
Data low-order	88H
CRC CHK low-order	EDH
CRC CHK high-order	5DH
END	Transmission time of 3.5 bytes

**RTU Slave machine responding information (normal)**

START	Transmission time of 3.5 bytes
Slave machine address	01H
Command code	08H
Detecting code high-order	00H
Detecting code low-order	00H
Data high-order	13H
Data low-order	88H
CRC CHK low-order	EDH
CRC CHK high-order	5DH
END	Transmission time of 3.5 bytes

**RTU Slave machine responding information (abnormal)**

START	Transmission time of 3.5 bytes
slave machine address	01H
Command code	88H
Error code	03H
CRC CHK low-order	06H
CRC CHK high-order	01H
END	Transmission time of 3.5 bytes

**Communication frame error check mode**

The standard MODBUS serial network adopts two kinds of error check mode: odd/even checking which is used to check every character and CRC detecting which is used to check one frame of data.

**1. Odd-even checking**

The users can configure the controller with odd or even checking, or no checking, what will determine how to set odd/even checking in every character.

If odd /even checking have been allocated, "1" bit will be accounted to the bit number of each character (7 bits in ASCII mode, 8 bits in RTU). For instance, the RTU character frame contAC80Cns the following 8 bits: 1 1 0 0 1 0 1

There are 4 bits with number"1". If using the even checking, odd/even checking bit of the frame will be 0, then there are still 4 bits with number"1". If using odd checking, odd/even checking bit of the frame will be 1, then there are 5 bits with number"1".

If odd/even checking has not been allocated, there will be no checking bit during the transmission, and no checking detection. One additional stop bit will be filled into the character frame in transmission.

## 2. CRC-16 (cycle redundant check)

While the RTU frame form in use; the frame has included the frame error detecting domAC80Cn which calculates base on the CRC method. The CRC domAC80Cn checks the content of the entire frame. The CRC domAC80Cn is two bytes, contAC80Cning binary values of 16 bits. It is added to the frame after calculated by the transmission equipment. The receiving equipment calculates CRC who receives frame agAC80Cn, and compares it with the value of the receiving CRC domAC80Cn. If both CRC value are not equal, it means the transmission has mistake.

CRC is firstly stored in 0xFFFF. Then a program is used to process the continuous 6 or above bytes in the frame and the value of current registers. Only 8Bit in every character is valid to CRC. Start bit、stop bit and parity check bit are invalid.

In the process of CRC coming out, each 8 characters independently XOR with register content. The result moves to lowest effective bit, and then the highest effective bit is filled with "1". LSB is extracted to be detected. If LSB is 1, the register independently XOR with the preset value. If LSB is 0, don't need XOR. This entire process needs to repeat 8 times. After the last bit (the eighth bit) is accomplished, next 8 bits byte will independently XOR with register content. All the final bytes in the frame are CRC value after processed.

This CRC operation method adopts the international standard CRC checking rule. Users can consult the relevant standard CRC operation while editing the CRC algorithm to compile out the CRC calculation program which is really meet the requirements.

Now here provide the user a simple CRC operation function (with C language programming):

```
unsigned int crc_chk_value(unsigned char *data_value, unsigned char length)
```

```
{
    unsigned int crc_value=0xFFFF;
    int i;
    while(length--)
    {
        crc_value^=*data_value++;
        for(i=0;i<8;i++)
        {
            if(crc_value&0x0001)
            {
                crc_value=(crc_value>>1)^0xa001;
            }
            else
            {
                crc_value=crc_value>>1;
            }
        }
    }
    return(crc_value);
}
```

### ●Communication data address definition

This part is the address definition of communication data. It is used to control the frequency inverter running and fetch frequency inverter mode information and frequency inverter relevant function parameter setting.

#### (1)AC80C serial function parameter address express rules

Take frequency inverter function parameter serial numbers as register address which are divided into the high byte and the low byte two parts. The high byte expresses the function parameter group serial numbers. The low byte expresses the inner serial numbers of each function parameter group. All need to be changed to hexadecimal.

Address domAC80Cn high byte definition:

Parameter code no	Head add of this group of parameter
F0 basic function parameter	0x0000 (not save in to EEPROM) 0x1000 (save in to EEPROM)
F1 running control parameter	0x0100 (not save in to EEPROM) 0x1100 (save in to EEPROM)
F2 quantum digital terminal parameter	0x0200 (not save in to EEPROM) 0x1200 (save in to EEPROM)
F3 quantum analog terminal parameter	0x0300 (not save in to EEPROM) 0x1300 (save in to EEPROM)
F4 keyboard and display parameter	0x0400 (not save in to EEPROM) 0x1400 (save in to EEPROM)
F5 motor parameter	0x0500 (not save in to EEPROM) 0x1500 (save in to EEPROM)
F6 VC control parameter	0x0600 (not save in to EEPROM) 0x1600 (save in to EEPROM)
F7 torque control parameter	0x0700 (not save in to EEPROM) 0x1700 (save in to EEPROM)
F8 V/F control parameter	0x0800 (not save in to EEPROM) 0x1800 (save in to EEPROM)
F9 plus function parameter	0x0900 (not save in to EEPROM) 0x1900 (save in to EEPROM)
FA malfunction protection parameter	0x0A00 (not save in to EEPROM) 0x1A00 (save in to EEPROM)
Fb PID control parameter	0x0B00 (not save in to EEPROM) 0x1B00 (save in to EEPROM)
FC multistep and PLC parameter	0x0C00 (not save in to EEPROM) 0x1C00 (save in to EEPROM)
Fd communication function parameter	0x0D00 (not save in to EEPROM) 0x1D00 (save in to EEPROM)
FE reserved	0x0E00 (not save in to EEPROM) 0x1E00 (save in to EEPROM)
FF reserved	0x0F00 (not save in to EEPROM) 0x1F00 (save in to EEPROM)
C monitor parameter	0x2100
Communication control parameter	0x3000 or 0x2000

Attention: because it is possible that the parameters are frequently rewritten exists in the communication, EEPROM are stored frequently. So its lifetime is cut down. As for the consumer, some function is unnecessary to store in the

communication mode, only changing the value of RAM inner can satisfy the usage requirement. As AC80C communication protocol stipulates to use writing order (06 H), if the parameter function code address domAC80Cn highest digit is 0, merely it write in the frequency inverter RAM, power down without storage, if the parameter function code address high half digit is 1, it write in EEPROM, namely power off with storage.

For instance, rewriting the function parameter **[F0.14]**, not depositing to EEPROM, address expresses for 000EH, depositing to EEPROM, address expresses for 100EH.

## (2)Communication control parameter address specification:

Function declaration	Address definition	Data meaning specification	R/W characteristic		
Communication given frequency	0x3000 or 0x2000	0~40000 is corresponding to 0.00Hz~400.00Hz	W/R		
Communication order setting	0x3001 or 0x2001	0000H: No order	W		
		0001H: FWD running			
		0002H: REV running			
		0003H: FWD jog			
		0004H: REV jog			
		0005H: speed-down stop			
		0006H: freely stop			
Frequency inverter state	0x3002 or 0x2002	Bit0	0: stop	1: running	R
		Bit1	0: no ACC	1: ACC	
		Bit2	0: no DEC	1: DEC	
		Bit3	0: FWD	1: REV	
		Bit4	0: inverter normal	1: inverter fault	
		Bit5	0: GPRS normal	1: GPRS locked	
Frequency inverter fault code	0x3003 or 0x2003	current frequency inverter fault code (refer to fault code table)	R/W		
Communication given upper frequency	0x3004 or 0x2004	0~40000 is corresponding to 0.00Hz~400.00Hz	W		
Communication given torque setting	0x3005 or 0x2005	0~2000 is corresponding to 0.0~200.0%	W		
Communication given max frequency in torque control FWD	0x3006 or 0x2006	0~2000 is corresponding to 0.0~200.0%	W		
Communication given max frequency in torque control REV	0x3007 or 0x2007	0~2000 is corresponding to 0.0~200.0%	W		
Communication given PID setting	0x3008 or 0x2008	0~1000 is corresponding to 0.0~100.0%	W		
Communication given PID feedback	0x3009 or 0x2009	0~1000 is corresponding to 0.0~100.0%	W		

**List of fault code meanings when message of slave machine is not correct**

Fault code	Meanings
1	Order code fault
2	Reserved
3	CRC not correct
4	Address not correct
5	Data not correct
6	Unable to modify when running
7	Reserved
8	Inverter busy
9	Value over limit
10	Reserved parameters unable to modify
11	Number of Bytes wrong when reading

## 10.3 Appendix 3: PG card manual

### 1. Summarize

AC80PG feedback card is mainly used for VC frequency inverter (AC80 series) feedback of motor speed and direction detection signal to achieve higher accuracy of motor speed and direction control.

### 2. Types and selections of PG card

Products consist of incremental encoder PG and rotary transformer PG. Encoder input signal type and feedback card output signal type as follows;

Type	Support input signal type	Type of PG output signal;	Suitable motor type
Incremental encoder PG	1.Difference signal input 2.Open collector circuit input 3.Push-pull signal input	1.Open collector circuit input(frequency division / no division) 2.Difference signal output(frequency division / no division)	AM
Rotary transformer PG	Rotary transformer signal input	None	AM/PM

### 3. Order model

#### Instructions of order model

## PG01-ABZ-05-C1

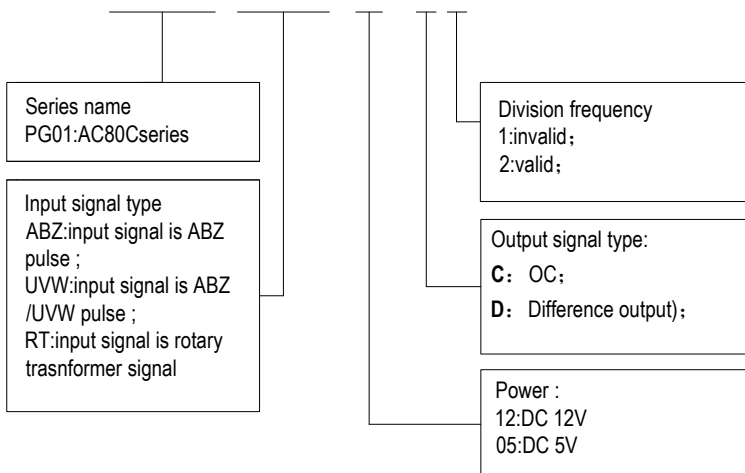



## 4. Incremental encoder PG instruction

### 4.1 product technical parameter

Power	Characteristic of input			Characteristic of output	
	Input signal	Respond frequency range	Input resistance	Output frequency range	Output current
5V/12V±5% 200mA	A B Z	0~300KHz	About 1000Ω	1-open collector circuit output:0~80KHz 2-Difference signal output: 0~300KHz	≤100mA
	U V W	0~100KHz			

### 4.2 Terminals function instruction

Terminals array of incremental encoder as follows:

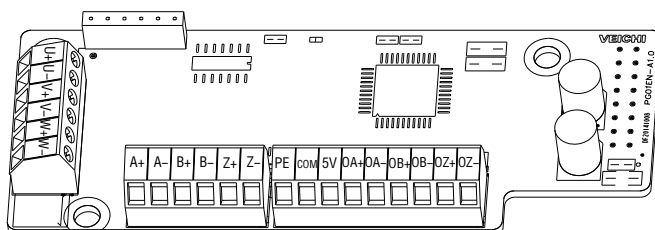

### 4.3 Main signal terminals function instruction

Terminal definition	Terminal name	Instruction
Power	5/12V	Support maximum current output 200mA
	PE	Ground
Common terminal	COM	Power earth
Output side of PG	OA+	Difference output A +signal(reused as A signal while open collector circuit output)
	OA-	Difference output A -signal
	OB+	Difference output B+ signal(reused as B signal while open collector circuit output)
	OB-	Difference output B-signal
	OZ+	Difference output Z+ signal
	OZ-	Difference output Z-signal
Input side of encoder	A+	Encoder difference A signal input(push-pull and open collector circuit output both compatible)
	A-	
	B+	Encoder difference B signal input(push-pull and open collector circuit output both compatible)
	B-	
	Z+	Encoder difference Z signal input(push-pull and open collector circuit output both compatible)

	Z-	compatible)
	U+	Encoder difference U signal input(push-pull and open collector circuit output both compatible)
	U-	
	V+	Encoder difference V signal input(push-pull and open collector circuit output both compatible)
	V-	
	W+	Encoder difference W signal input(push-pull and open collector circuit output both compatible)
	W-	

1. Input signals of A+,A-,B+,B- are two group orthogonal pulse. A group consists of opposite signals named A+ and A-. B group consists of opposite signals named B+ and B-. And both are orthogonal .Function is the same as open collector circuit and push-pull encoder.

2. Input terminal named Z+, Z- are zero position signals. Encoder will give one group of Z signals every circle.

3. Input signals named U+,U-,V+,U-,W+,W- are PM position detecting signals .Both of three groups have 120° angle.

**Note: Terminals named OA+, OB- are reused as open collector circuit encoder input signals. But both used at the same time is forbidden**

4.4 Switch terminals instruction

Switch terminals are 8 bits used as PG division frequency ratio. Ratio of division frequency is equal to 2 multiply binary system number what switch terminals stand for. When switch ON means invalid, OFF means valid. Examples as follows

Selection terminals when used as division frequency	CON4		$f_o=f_i$
			$f_o=f_i/2$
			$f_o=f_i/4$
			$f_o=f_i/6$
		...	

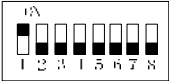
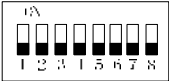
			fo=fi/508
			fo=fi/510

#### 4.5 Related parameters

Please set parameters according to what you need. Related parameters as follows.

Function code	Name
F0.00	Control mode
F5.15	Type of rotary encoder
F5.16	Numbers of pulse every circle

#### 4.6 Note of connection

- 1, Please select shielded cable used as signal wires in case of interference.
- 2, Encoder shielded cable should best connect to earth alone in case of interference
- 3, Signal cable should be separated from power cable, and parallel lines are forbidden

4.7 Wiring 1

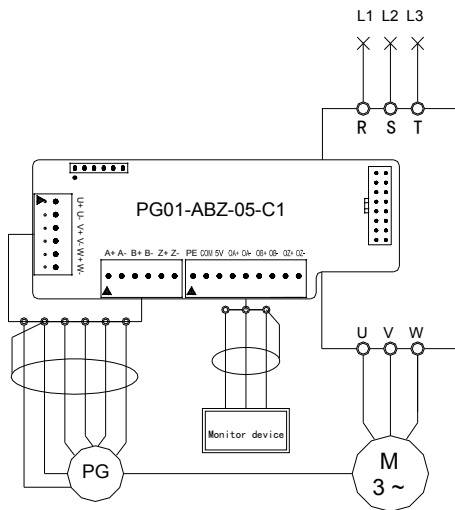

4.8 Application wiring

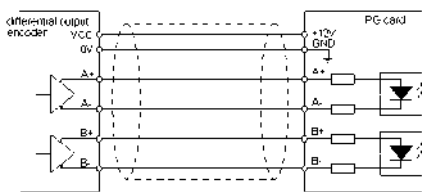

Differential output encoder wiring

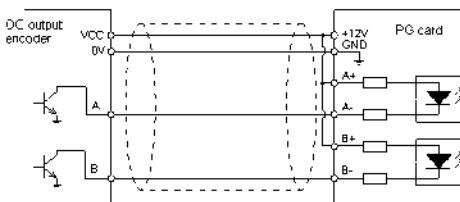

OC output encoder wiring

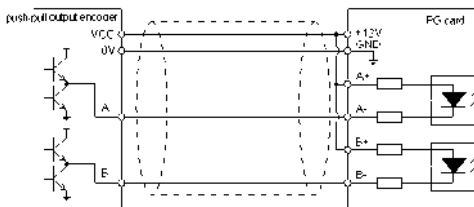

Push-pull output encoder wiring

## 5. Rotary transformer PG instruction

### 5.1 Function instruction

Output signals of rotary transformer are two phase orthogonal analog signals. Voltage of them is changing as sine and cosine curve following angle. Frequency is the same as exciting frequency

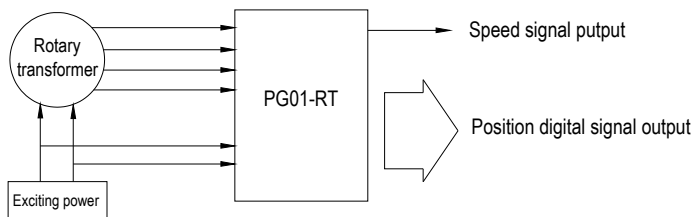

### 5.2 Instruction of terminals function

Terminals array of rotary transformer PG as follows:

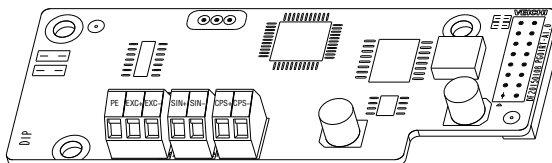

### 5.3 Main terminals instruction

Terminals definition	Terminals name	Instruction
output	PE	Earth
	EXC+	Driving source output
	EXC-	Driving source output
input	COS+	Cosine signals input
	COS-	
	SIN+	Sine signals input
	SIN-	

Waves below includes rotary transformer driving source, sine and cosine feedback. Enveloping lines of sine and cosine have the same frequency as exciting frequency

## 5.4 Wiring

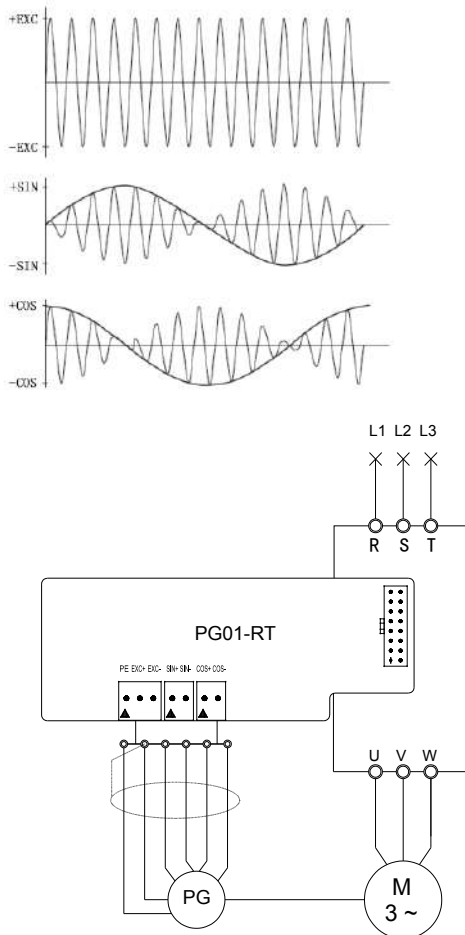

## 5.5 Note of connection

- 1, Please select shielded cable used as signal wires in case of interference .
- 2, Encoder shielded cable should best connect to earth alone in case of interference
- 3, Signal cable should be separated from power cable, and parallel lines are forbidden

## 4. Installation size

### 4.1 Installation show

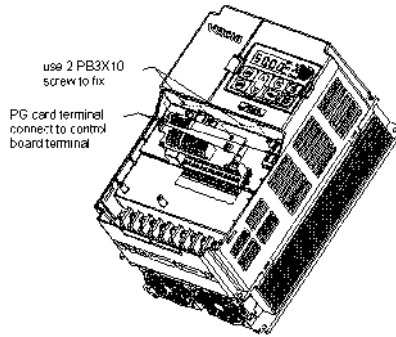

### 4.2 Installation size

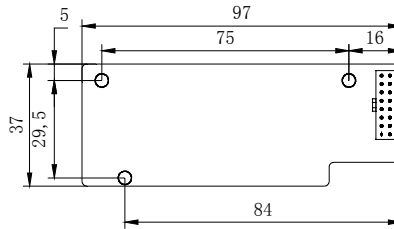

## 10.4 Appendix 4: Profibus-DPcard manual

### 1. Profibus-DP card installation

Before installing please make sure switch off power supply, and wait 10 minutes when the power supply indicators LED is off. Profibus-DP card embed to inside of inverter, where under the removable cover. See Fig. 1-1.

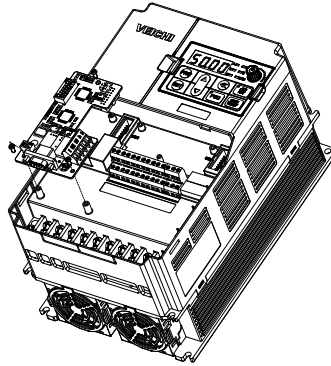

Fig.1-1 Profibus-DP card installation method

### 2. Profibus-DPcard I/O describe

#### 2.1 Product models describe

Product model	Product describe	Detail
ACDP04	General Profibus-DP extension card	+24V,COM get power from control card

#### 2.2 Products connection schematic diagram

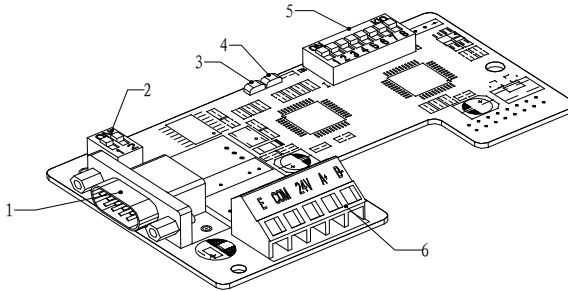

Fig. 2-1ACDP04 connection

- 1: Profibus-DP connector
- 2: Inside terminal resistor selecting slide switch
- 3: Indicator LED D1
- 4: Indicator LED D2
- 5: Profibus-DP slaves address slid switch
- 6: Ports of ACDP04 communication with AC80C by RS485



### 3.Wiring

Profibus-DP adopts RS-485 physical transmission method. Please wiring with Profibus-DP standard cable to ensure communication system has good quality and stable. The relationship of the transmission rate selecting of Profibus-DP standard cable between allowable maximum length as diagram showing:

Diagram Profibus-DP standard cable selecting transmission rate relationship with allowable maximum length

Bus speed rate	9.6	19.2	93.75	187.5	500	1500	6000	12000
Length of cable A (m)	1200	1200	1200	1000	400	200	100	100
Length of cable B (m)	1200	1200	1200	600	200	100	100	100

Profibus-DP standard connector, Fig 3-1.

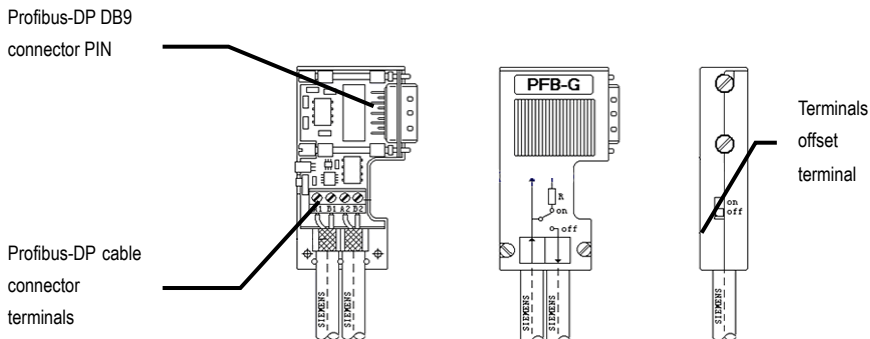

Fig 3-1, Profibus-DP standard connector

When configure PLC as Profibus-DP master, connect with 3 variable frequency inverter as slave devices as show Fig 3-2.

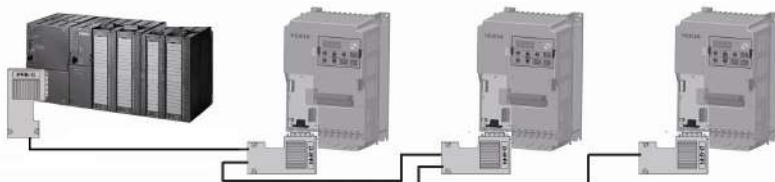

Fig 3-2 connection diagram

#### Note:

1. Please use multimeter to check PIN 3 (A data cable) of every connector of Profibus-DP connection is ON or not, and PIN 8 (B data cable) is ON or not. Place terminal offset resistor switch of both connecting connector to ON position (Or slide terminal switch of DP card for ON), Place terminal offset resistor switch of both connecting connector to OFF position (or slide terminal switch of DP card for OFF), please check resistor between data cable A and data cable B, it should be 110  $\Omega$  around.
2. Please make a good solution for anti interference. To avoid place cable of communication parallel with power cable, ensure the cover of slave device and shield layer of communication cable share the same grounding. Ensure the E grounding terminal of DP card has good connecting with grounding terminals of VFD.
3. The maximum slots is 10, the setting number can't over this setting.

## 10.5 Appendix 5: LCD keyboard manual

### 1. Function characteristic

LCD keyboard is designed for user checking function parameters more directly. Language of LCD keyboard includes English and Chinese, and is compatible with other LED keyboard designed by our company.

It can display two monitoring parameters at the same time when inverter stops or runs.

States of running, stop and fault all have vivid image that makes user to understand and remember states of inverter more conveniently.

It also has parameter copy and download functions, and can download parameters of same series inverter. It is convenient for user to change batch parameters.

Potentiometer is also on the keyboard and used for changing given frequency.

Note:

1. If special type inverter needs LCD keyboard, please contact with our company.
2. User must confirm that type of LCD keyboard and type of inverter are suited.

Software version of LCD	Type of inverters
KB10B	AC70
KB30B	AC80B
KB50B	AC80C
KB70B	AC100

### 2. Monitor menu

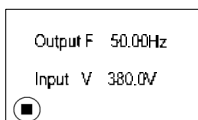

Chart 1 (a) at stop state

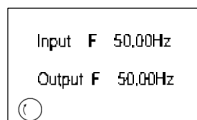

Chart1 (b) at FWD running state

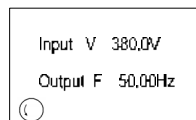

Chart1 (c) at REV running state

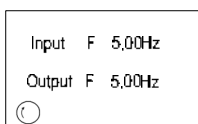

Chart1 (d) at JOG FWD state

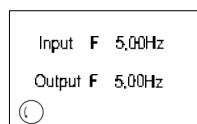

Chart1 (e) at JOG REV state

It can display two monitoring parameters and running or stop status every state of inverter, details refer to chart 1. User can select first -line monitoring parameters by **SET**, and select second-line monitoring parameters by **←**.

### 3. Monitoring parameter menu

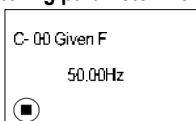

Chart 2 Monitoring menu

Please press **PRG** key long time for 1s, then it will go into monitoring menu as chart 2. And user can check parameters by **↑** or **↓** key, pressing **PRG** or **SET** key to return back.

## 4. Parameters menu

### (1) First level menu

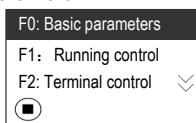

Chart 3 first level menu

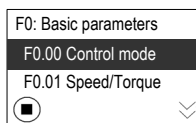

Chart 4 second level menu

Press **PRG** key into first level menu, and it can display three parameters. User can select anyone of them by press **^** or **v** key. Press **PRG** key to return back. Pressing **SET** key means selecting the item, and then return back.

### (2) Second level menu

When using AC80 series in the first level menu, press **PRG** key to go into second level menu. When using AC60 series in main menu, press **PRG** key to go into menu. It displays first level menu items in first line, and displays second level menu items in second line. Position of cursor is factory default setting. Press **<<** key to replace items, Press **^** or **v** key to move cursor, Press **PRG** key to return, Pressing **SET** key means selecting the item, and then return back.

### (3) Third level menu

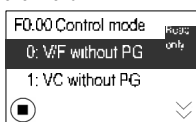

Chart 5 (a) changing line

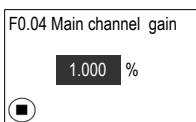

Chart 5 (b) data

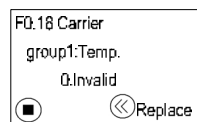

Chart 5 (c) group

After going into second level menu, press **PRG** key to go into third level menu. Third level menu includes three kinds, changing line, data and group.

Changing line: First line displays second level items, second and third line display third level items, and position of cursor is factory default setting, details refer to chart 5(a)

Press **<<** key to replace items

Press **^** or **v** to move cursor

Press **PRG** to return back

Press **SET** to select item, and then return back.

Data: First line displays second level menu items, and second line displays data, details refer to chart 5(b)

Press **<<** to replace items

Press **^** or **v** to increase or decrease data while pressing **<<**, Press **^** or **v** to increase or decrease data from lowest bit without pressing **<<**

Press **PRG** to return back.

Press **SET** to confirm modifying data, and then return back.

Group: First line displays second level menu items, second line displays group number, and third line displays third level menu items, details refer to chart 5(c)

Press **<<** to change another group, Press **^** or **v** to change items,

Press **PRG** key to return back.

Press **SET** to confirm modifying items, and then return back.

If pressing **^** or **v** cannot modify items in third level menu, and display "Read only" all that reminder user of parameter is not allowed to modify or when inverter is running, modifying is forbidden

5. Fault

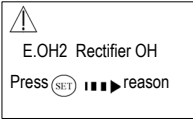

Chart 6 (a) fault

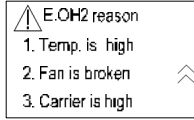

Chart 6 (b) fault reason

Fault: First line displays fault icon shiningly, second line displays fault code and name, and third line reminder user of pressing [SET] to check fault reasons, details refer to chart 6(a). Press [SET] to go into fault reason.

Press [STOP/RESET] to reset fault when fault has been cleared

Fault reason: First line displays fault icon, code and name, other lines display reasons, details please refer to chart 6(b).If there up or down arrows, please press [UP] or [DOWN] to change another page to check reasons;

Press [PRG] or [SET] to return back

6. Terminal state

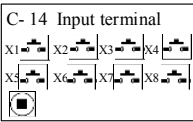

Chart 7 (a) input terminal

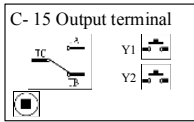

Chart 7 (b) output terminal

Input terminal: details please refer to chart (a)

Output terminal: details please refer to chart7 (b)

Note: If monitoring items are both terminal state in both lines, it will displays input terminal firstly.

7. Parameters copy

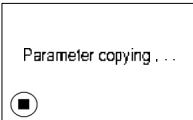

Chart8 (a) copying

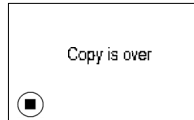

Chart8 (b) copy complete

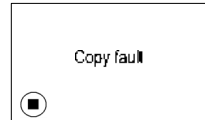

Chart8 (c) copy fault

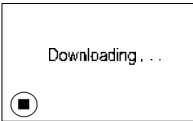

Chart8 (d) download

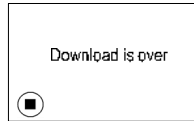

Chart8 (e) download complete



Chart8 (f) download fault

Parameter copy: details please refer to chart 8 (a),8(b),8(c)

Check F4.05 and select item "sending to keyboard from inverter", and then press [SET].When it displays "completely copy ", it means finishing copy operation details refer to chart 8(b).When it displays "copy fault" ,it means operation is failed, details please refer to chart 8(c).Press [PRG] key to return .

Download: same as copy

Note: Inverters must be the same series, when downloading parameters

8. Self -tuning

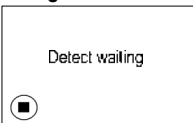

Chart 9 (a) waiting

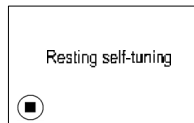

Chart9 (b) resting type self-tuning

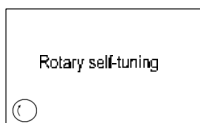

Chart 9 (c) rotary type self-tuning

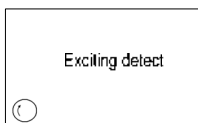

Chart 9(d) exciting magnetic detecting

Resting type self-tuning: steps as chart 9 (a),(b)and(d).Please set F5.12=2,and press **SET** key to go into motor detecting waiting menu, details refer to chart 9(a).Then press **FWD** key, and it will display resting self-tuning, details refer to 9(b).It displays "exciting detecting" when self-tuning is over, details refer to chart 9(d), then it will return back automatically.

Rotary self-tuning: steps as chart 9 (a), (c) and (d). Please set F5.12=1,and press **SET** key to go into motor detecting waiting menu, details refer to chart 9(a).Then press **FWD** key, and it will display resting self-tuning, details refer to 9(b), while resting self-tuning is over, it displays rotary self-tuning, details refer to chart9(c).After rotary self-tuning over, it displays exciting detecting, details refer to chart 9(d), then it will return back automatically.

## 9. Other menus

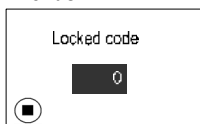

Chart 10 (a) keyboard locked

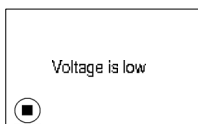

Chart10 (b) low voltage

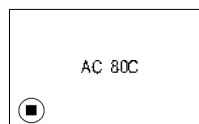

Chart 10 (c) model of inverter

Keyboard locked: as chart 10(a).Keyboard will display locked menu when going into next menu, after user setting password and selecting parameter locked function. Please type correct password and then go into next menu.

Low voltage: as chart10 (b).When input voltage is low, it will display this warning.

Model of inverter, as chart10(c).When power on, if communication is ok, it will display this menu, and if not, it will display keyboard connection fault.

## Warranty Card

**Profile**

User Name : \_\_\_\_\_

Address : \_\_\_\_\_

Contacts : \_\_\_\_\_ Phone : \_\_\_\_\_ Fax : \_\_\_\_\_

Model : \_\_\_\_\_ Machine Code : \_\_\_\_\_

**Agent/Distributor Profile**

Delivery Company : \_\_\_\_\_

Contacts : \_\_\_\_\_ Phone : \_\_\_\_\_ Delivery Date : \_\_\_\_\_

## Warranty Clauses

The Company solemnly states that since the day users purchase from my company (hereinafter referred to as manufacturer),they can enjoy the following warranty services;

- 1.Since the date of purchase, users can enjoy the following warranty services of the product:
  - 1) Within 30 days after shipment,the company promises returning,replacement and maintenance of the product.
  - 2) Within 90 days after shipment,the company promises replacement and maintenance of the product.
  - 3) Within 18 months after shipment,the company promises only maintenance of the product.
  - 4) Products exported to countries except China shall not enjoy the warranties mentioned above.
2. Since the date of purchase, users can enjoy the service of the company when they pay for the service.
3. Exception Clauses: Product failures caused by the following reasons would not enjoy the free warranty services of the manufacturer:
  - 1) Failures caused by operations of users that is not operated in accordance with the requirements of the product manual;
  - 2) Failures caused when users repair or renovate the product without communicating with the manufacturer in advance;
  - 3) Failures caused by abnormal aging of the product resulted from poor using environment;
  - 4) Failures caused by earthquake, fire or other natural disasters or abnormal voltage;
  - 5) Failures caused by damage during transportation(mode of transportation is decided by users and the company only helps to handle cargo shipment procedures).
4. In the following conditions, the manufacturer have the right not to provide warranty services:
  - 1) When the marks,trademarks or nameplates of the products are destroyed or can not be identified;
  - 2) When users do not pay for the product according to signed contract;
  - 3) When users intentionally hiding the improper operations during installation, wiring and maintenance;
5. For products that enjoy all returning,replacement and maintenance services, first the product should be returned to the company and after responsibility confirmation,the product can be replaced or repaired.

## Certificate of Approval

QC check : \_\_\_\_\_



The product has been checked and proved to be qualified for delivery in conformity with standard.